

**US
M14 and
M14A1
Rifles
FM23-8**

**Rifle
Marksmanship**

M14 AND M14A1 RIFLES, AND RIFLE MARKSMANSHIP

	Paragraph	Page
CHAPTER 1. INTRODUCTION	1-3	3
CHAPTER 2. MECHANICAL TRAINING		
Section I. Characteristics	4-5	5
II. Disassembly and assembly	6-16	8
III. Operation and lunninging	17-18	28
IV. Stoppages and immediate action	19-20	39
V. Maintenance	21-25	41
VI. Ammunition	26-29	54
VII. Accessories	30-35	56
CHAPTER 3. RIFLE MARKSMANSHIP FUNDAMENTALS		
Section I. General	36-37	64
II. Marksmanship fundamentals	38-43	64
CHAPTER 4. PREPARATORY MARKSMANSHIP TRAINING AND 25-METER FIRING		
Section I. Preparatory marksmanship and conduct of training	44-45	84
II. M14 and M14A1 sights	46-50	92
III. Battlesight zero	51-54	94
CHAPTER 5. FIELD FIRING		
Section I. Conduct of training	55-61	98
II. Range operation	62-63	99
CHAPTER 6. TARGET DETECTION		
Section I. General	64-65	105
II. Range organization and management	66-69	103
III. Conduct of training	70-75	110
IV. Creep and thump techniques	76-79	120
CHAPTER 7. AUTOMATIC RIFLE MARKSMANSHIP	80-89	123
CHAPTER 8. QUICK FIRE		
Section I. General	90-91	151
II. Quick fire with the M14 rifle	92-93	151

		Paragraph	Page
CHAPTER	9. RECORD FIRE		
Section	I. General	94-95	154
	II. Record fire—daytime	96-98	154
	III. Record fire—nighttime	99-106	161
	IV. Procedures for connecting 15 modified M31A1 target holding mechanisms to one M40 counter device; and modification of the M31A1 mechanism	107-112	173
CHAPTER	10. ADVANCED RIFLE MARKSMANSHIP		
Section	I. Fundamentals	113-117	178
	II. Ballistics	118,119	192
	III. Detection and correction of errors	120,121	204
APPENDIX	A. REFERENCES		207
	B. METRIC CONVERSION TABLES		208
	C. KNOWN DISTANCE FIRING		210
	D. TARGET DETECTION EXERCISES		214
INDEX			234

Addendum

1. FM 23-8, April 1974, is changed as follows:

Page 153. Add the following:

b. General. Instructional firing is practice firing on a marksmanship range with help from an instructor. The coach and firer method may be used.

b. Purpose. Instructional firing with the M14 and M14A1 develops the skill needed to engage targets during record fire.

c. Procedure. Instructional firing uses the same procedures for conducting record fire 1. Coaches and instructors will critique firers during this exercise. All rounds are scored, but the scores are diagnostic and do not count toward qualification.

2. Post these changes per DA pamphlet 310-13

3. File this change in the front of the publication.

INTRDDUCTION

1. Purpose and Scope

This manual provides guidance for presenting instruction with the M14 and M14A1 rifles. It contains a detailed description of the rifle and its general characteristics, procedures for disassembly and assembly, operation and functioning of the rifle, types of stoppages and action to reduce them, types of ammunition, maintenance, fundamentals of rifle marksmanship, battlesight zero, field firing, target detection, automatic fire, quick fire pointing technique, record fire, and advanced marksmanship training.

2. Objectives

The objectives of the United States Army rifle marksmanship program are to—

a. Develop in every soldier during training—

(1) The confidence, will, knowledge, and skills required to fire a rifle and his enemy personnel in combat.

(2) The ability to apply correct techniques of rifle marksmanship when functioning as an individual in a unit engaged in combat.

b. Insure that every soldier maintains a continuing degree of proficiency in combat rifle firing, consistent with the mission of the unit to which he is assigned.

c. Provide in time of peace a large number of shooters from which potential precision marksmen can be selected and further trained to successfully compete in interservice, civilian, and international competition.

d. Provide in time of war, an instructor base of cadre for sniper training, if it is required.

e. Insure that every soldier can properly maintain his weapon.

3. Training Conditions

a. The procedures and techniques used in the United States Army rifle marksmanship training program are based on the concept that riflemen must be proficient marksmen capable of effectively applying their shooting skills in combat. The degree of proficiency attained by a rifleman is largely dependent upon correct instruction and the proper application of marksmanship fundamentals. Initially, during marksmanship training, emphasis is placed on learning or reviewing shooting fundamentals. These fundamentals are taught in an environment designed to prepare soldiers for

combat-type training exercises. Thus, emphasis on the combat applications of marksmanship is gradual, and such training is based on conditions affecting marksmanship on the battlefield. The more common of these battlefield conditions are as follows:

(1) Enemy personnel are seldom visible except in the assault.

(2) Most combat targets are linear in nature and will consist of a number of men or objects irregularly spaced along covered or concealed areas such as ground folds, hedges, and borders of woods.

(3) Most combat targets can be detected by smoke, flash, dust, noise, or movement and will only be visible for a brief moment.

(4) Combat targets can be engaged by using nearby objects as reference points.

(5) The range at which individual personnel targets can be detected and effectively engaged will rarely exceed 300 meters.

(6) The nature of the target, irregularities of terrain, and vegetation will generally require a rifleman to use a position other than the prone position to place effective fire on the target. In a defensive situation the rifleman will usually be firing from a foxhole position or other type defensive emplacement.

(7) Selecting an aiming point in elevation is difficult because of the low outline and obscurity of most combat targets.

(8) The conditions of rifle fire in combat rarely require or permit mechanical adjustments of the rear sight.

(9) Targets in combat requiring time-pressure fire are basically of two types:

(a) A single fleeting target that must be engaged within a minimum unknown time period.

(b) A number of distributed targets engaged within the time they remain available. In the latter case the firer, at times, may select the time spent in engaging individual targets.

b. Competition between individuals and units is an effective means of motivating the individual and building unit pride, but they should never be fostered at the expense of the ultimate objective of the marksmanship program—to produce well-trained combat riflemen. Should that objective become secondary to obtaining high scores on the range or qualifying the maximum number of

soldiers, then it is only a matter of time before the more difficult aspects of the marksmanship course(s) are either eliminated or simplified to the point of being useless.

c. None of the marksmanship courses,

techniques, requirements, or objectives outlined in this manual are beyond the capability of any individual who has been found physically qualified for military service provided he is given correct instruction and proper supervision.

CHAPTER 2

MECHANICAL TRAINING

Section I. CHARACTERISTICS

4. Description of the Rifles

a. M14 Rifle.

(1) The US rifle, 7.62-mm, M14 (fig 1) is a lightweight, aircooled, gas-operated, magazine-fed, shoulder weapon. It is designed primarily for semiautomatic fire.

(2) When employed as an automatic rifle, the selector and M2 hipod must be installed (fig 2).

(3) The flash suppressor is designed with a wide rib on the bottom to reduce muzzle climb and the amount of dust raised by muzzle blast.

(4) The lug on the rear of the flash suppressor is used to secure a bayonet, a grenade launcher, or a blank firing attachment.

(5) The spindle valve is located just forward of the front band between the barrel and gas cylinder. The valve's function is to control the gases

used to operate the rifle. When the slot of the spindle valve is in the vertical or ON position, the valve is open and gases necessary for the functioning of the rifle pass into the gas cylinder. When the slot of the spindle valve is in the horizontal or OFF position, the valve is closed. When the valve is closed, it permits the full pressure of the gas to be utilized to propel a rifle grenade and it also prevents the bypass of gas into the gas cylinder.

b. M14A1 Rifle

(1) The US rifle, 7.62-mm, M14A1 (fig 3) is an aircooled, gas-operated, magazine-fed, shoulder weapon. It is capable of semiautomatic or automatic fire; however, it is designed primarily for automatic fire. It features a stabilizer assembly, modified hipod, front and rear handgrip, straight line stock, and rubber recoil pad.

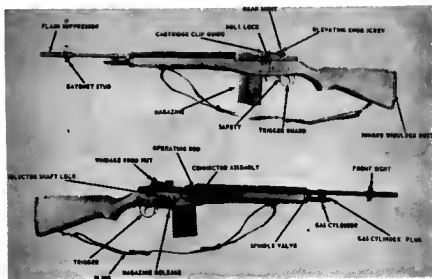

Figure 1. M14 rifle.

SELECTOR

WINGED SHOULDER REST



Figure 2. M14 rifle with selector and MS bipod.

STABILIZED ASSEMBLY

LONG SLING

FRONT HAND GRIP

MODIFIED BIPOD 42

PISTOL GRIP

BUTT STABILIZER

SOCKET



Figure 3. M14A1 rifle

(2) The M14A1 stock group is the "straight line" type with a fixed pistol grip and folding front handgrip which lies flat along the bottom of the stock when not in use. The location of the front handgrip can be adjusted to one of five positions in 2.5 cm (1 inch) increments to accommodate all firers. The rubber recoil pad reduces the effects of recoil. The hinged shoulder rest provides vertical control of the butt end of the rifle. The butt sling swivel pivots 90 degrees to the left to facilitate carrying of the weapon.

(3) The stabilizer assembly consists of a perforated steel sleeve which slides over the flash suppressor and is fastened to the bayonet lug by a screw and a locknut. The stabilizer provides muzzle stability and reduces recoil.

(4) The M2 bipod is modified by the addition of a sling swivel and a longer yoke assembly pin to accommodate the swivel.

(5) The M14A1 utilizes a sling with an extra hook assembly. The portion of the sling between the handgrip and the bipod provides additional muzzle control during firing. It allows the average firer, by applying rearward pressure on the front handgrip, to increase the pressure of the bipod on the ground to approximately 16 kilograms (35 pounds), reducing dispersion considerably. When the weapon is carried at sling arms, the sling must be disconnected from the handgrip assembly.

5. General Data

a. Weights.

	Kilograms	(Pounds)
M14 rifle with full magazine and cleaning equipment	4.59	10.11
M14 rifle with full magazine, cleaning equipment, selector, and bipod	5.34	11.651
Empty magazine23	0.51
Full magazine (with ball ammunition)68	1.51
Cleaning equipment27	0.60
M2 bipod80	1.753
M14A1 rifle with full magazine	5.95	13.121

b. Lengths.

	Centimeters	(Inches)
M14, overall, with flash suppressor	112.5	44.31
M14A1, overall with stabilizer assembly	112.5	44.31

c. Sights.

Front	Fixed.
Rear	Adjustable, one disk of elevation on windage moves the strike of the bullet .7 centimeters at 25 meters (2.8 cm on 1.1 inch at 100 meters).

d. Ammunition See paragraph 26.

e. Trigger Pull.

	Kilograms	(Pounds)
Minimum	2.0	4.51
Maximum	3.4	7.51

f. Operational characteristics.

	Meters per Second	Feet per Second
111 Muzzle velocity	854	12801
121 Cyclic rate of fire (rounds per minute)	150	

13) Rates of fire. These

can be maintained without danger to the firer or damage to the weapon.

(a) Semiautomatic Rounds

per minute for a maximum period of:	
2 minutes	40.
10 minutes	30.
20 minutes	20.
20 minutes (or more)	15.

(b) Automatic Rounds

per minute for a maximum period of—	
1 minute	40.
2 minutes	50.
5 minutes	40.
15 minutes	30.
20 minutes	25.
30 minutes (or more)	20.

14) Range.

	Meters
Maximum effective (semiautomatic, without bipod)	460.
Maximum effective (semiautomatic, with bipod)	700.
Maximum effective (automatic, with bipod)	460.
Maximum	3725.

g. Terms.

- 11) Cyclic rate of fire The maximum rate at which a weapon fires automatically.
- 12) Maximum range The greatest distance the projectile can travel.
- 13) Maximum effective The greatest distance at which a weapon may be expected to fire accurately to inflict immediate w damage.

Section II. DISASSEMBLY AND ASSEMBLY

6. General

a. The soldier is authorized to disassemble his rifle to the extent called field stripping. Chart 1 shows the parts he is permitted to disassemble with and without supervision. The extent of disassembly

he is permitted to perform without supervision is adequate for normal maintenance. Additionally he may disassemble the gas system, but only when it is required to insure continued functioning of the rifle.

Chart 1. DISASSEMBLY AUTHORIZATION

Part	Soldier	Attender	Maintenance personnel
SEPARATION INTO THREE MAIN GROUPS	X		
DISASSEMBLY:			
BARREL AND RECEIVER GROUP	X		
Front sight			X
Rear sight		X	
Flash suppressor		X	
Spindle valve			X
Sear release		X	
Selector and selector shaft lock		X	
Bipod M2	X		
Connector assembly (spring and plunger)			X
Bolt lock			X
Cartridge clip guide			X
Operating rod guide			X
Barrel from receiver			X
Stabilizer assembly M14A1	X		
STOCK GROUP:			
Stock liner			X
Upper sling swivel bracket			X
Stock ferrule			X
MAGAZINE	X		
BOLT		X	
Bolt roller from bolt stud			X
FIRING MECHANISM		X	
Magazine latch			X
Sear from trigger			X

b. The frequency of disassembly and assembly should be kept to a minimum consistent with maintenance and instructional requirements. Constant disassembly causes excessive wear of the parts and leads to their early unserviceability and to inaccuracy of the weapon.

c. The rifle has been designed to be taken apart and put together easily. No force is needed if it is disassembled and assembled correctly. The parts of one rifle, except the bolt, may be interchanged with those of another when necessary. For safety reasons, bolts should never be interchanged.

d. As the rifle is disassembled, the parts should be laid out from left to right, on a clean surface and in the order of removal. This makes assembly easier because the parts are assembled in the reverse order of disassembly. The names of the parts (nomenclature) should be taught along with disassembly and assembly to make further instruction on the rifle easier to understand.

7. Clearing the Rifle

The first step in handling any weapon is to clear it.

To clear the rifle, first attempt to engage the safety. (If unable to place the safety in the safe position, continue with the second step.) Remove the magazine by placing the right thumb on the magazine latch and curl the remaining fingers around the front of the magazine. Press in on the magazine latch, rotate the base of the magazine toward the muzzle end of the rifle (fig 4), and remove it from the magazine well. With the knife edge of the right hand, pull the operating rod handle all the way to the rear, reach across the receiver with the right thumb, and press in on the bolt lock (fig 5). Check the safety to see that it is engaged (position it in the SAFE position if it is not), tilt the rifle, and look inside the chamber and receiver to insure that they contain no rounds.

8. Disassembly Into Three Main Groups

a. The three main groups are the firing mechanism, the barrel and receiver, and the stock.



Figure 4 Removing the magazine



Figure 5. Locking the bolt to the rear

b. After the rifle is cleared, the operating parts should be returned to their forward positions for disassembly. To do this, pull back on the operating rod handle, release it, and allow the bolt to go forward.

c. To remove the firing mechanism, grasp the rear of the trigger guard with the thumb and forefinger of your right hand and pull downward and outward until the mechanism is released (fig 6). Lift out the firing mechanism.

Caution: In withdrawing the firing mechanism from the stock, DO NOT rotate the trigger guard more than 90 degrees. Partial withdrawal of the firing mechanism, when combined with rotating the trigger guard more than 90 degrees, causes damage to the rib or keyways on the side of the firing mechanism housing.

d. To separate the barrel and receiver from the stock, lay the weapon on a flat surface with the sights up and muzzle to the left. Grasp the receiver with the left hand over the rear sight and raise the

rifle few centimeters. With the right hand, strike down on and grasp the small of the stock, separating the barrel and receiver from the stock. The components of the M14 are shown in figure 7.

e. The components of the M14A1 rifle are shown in figure 8.

9. Disassembly of the Barrel and Receiver Group

a. *Removing the Connector Assembly.* Place the barrel and receiver group on its left side with the operating rod handle up and the muzzle away from you. On rifles modified for automatic firing, press in and turn the selector until the face marked "A" is toward the windage knob (fig 9). With the bolt closed, place the right thumb on the rear of the connector assembly, the first finger on the rear release bracket and the second finger inside the rear of the rear release bracket and the second finger inside the rear of the receiver (1, fig 10). Push forward with the thumb until the forward end of the assembly can be lifted off the connector lock with the thumb and forefinger of the left hand (2,

fig 101. (Note that the rifle shown in 1, 2, and 3, fig 10 has not been modified for automatic firing). Turn the connector assembly fig. 101 clockwise until the elongated hole in the connector assembly is lined with the elongated stud on the sear release. Lower the front end of the connector assembly and tilt the rear end off the elongated stud of the sear release.

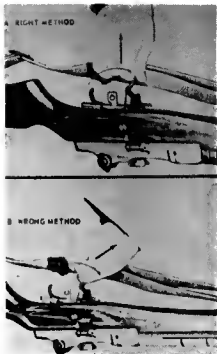

Figure 6 Removing the firing mechanism

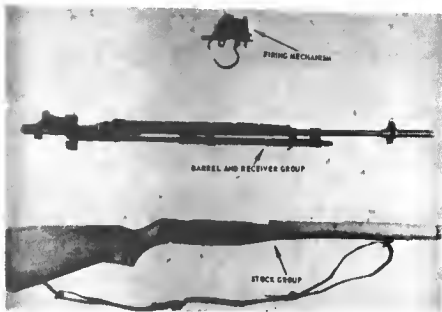

Figure 7. Components of the M14 rifle

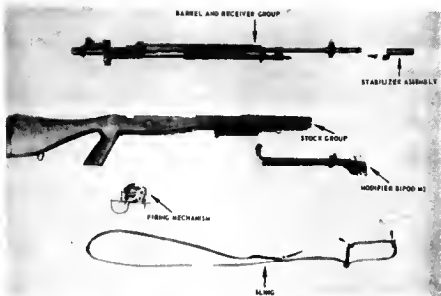

Figure 8 Components of the M14A1 rifle



Figure 9 Position of the selector for removing the connector assembly (rifle modified for selective firing)



1

Figure 18. Removing the connector assembly.



2

Figure 18—Continued

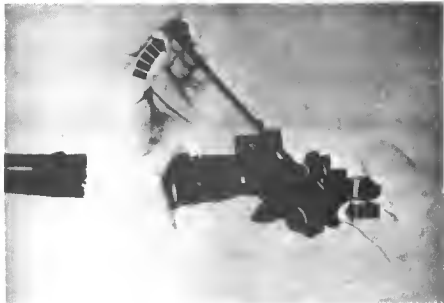

3

Figure 10—Continued.

b. Removing the Operating Rod Spring and Operating Rod Spring Guide Place the barrel and receiver group on a flat surface, sights down, muzzle to the left. With the left hand, pull toward the muzzle on the operating rod spring to relieve pressure on the connector lock 11, fig 111. With the right forefinger, pull the connector lock toward you and, allowing the operating rod spring to expand slowly, disconnect and remove the operating rod spring and operating rod spring guide 12, fig 111. Separate these two parts.

c. Rotating the Operating Rod Turn the barrel and receiver group so the sights are up and the muzzle is pointing away from you. Pull back the operating rod handle until the guide lug on its inside surface is lined with the disassembly notch on the right side of the receiver. Rotate the operating rod downward and outward, then pull it to the rear, disengaging it from the operating rod guide (fig 121).

d. Removing the Bolt Group the bolt by the roller end, while sliding it forward, lift it upward

and outward to the right front with a slight rotating motion (fig 131).

e. Rifle Field Stripped. The parts of the barrel and receiver group in their order of disassembly are shown in figure 14.

Note. The bolt, rear sight, and the firing mechanism will not be disassembled by the soldier under any circumstances (chart 1).

10. Assembly of the Barrel and Receiver Group

a. Replacing the Bolt Place the barrel and receiver on the table, sights up, muzzle pointing away from you. Hold the bolt by the roller end and locking lug and place the rear on the bridge of the receiver, firing pin tang pointed down. Turn the bolt slightly counterclockwise until the tang of the firing pin clears the bridge. Guide the left locking lug of the bolt into its groove on the left side of the receiver. Lower the right locking lug on its bearing surface and slide the bolt halfway to the rear.



Figure 11 Removing the operating rod spring and operating rod spring guide





Figure 12 Removing operating rod



Figure 13. Removing the bolt

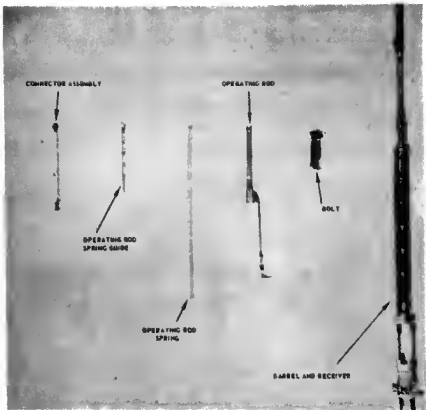

Figure 14 Parts of the barrel and receiver group in order of disassembly

b. *Replacing the Operating Rod.* Holding the operating rod at the handle, place the front end into the operating rod guide and position the rod so that the recess in the hump fits over the bolt roller. Turn the operating rod to the left until the guide lug fits into the disassembly notch on the receiver, then move the operating rod forward until the bolt is closed.

c. *Replacing the Operating Rod Spring and Operating Rod Spring Guide.* Turn the barrel and receiver over so the sights are down and the muzzle is to the left. Place the operating rod spring guide into the operating rod spring hump up, and feed the loose end of the spring into the operating rod. Grasp the spring and guide with the left hand and compress the spring until the hole in the guide can be aligned with the connector lock. Lower the guide and push the connector lock in with the right thumb (fig 15).

d. *Replacing the Connector Assembly.* Place

the barrel and receiver on its side with the operating rod handle up, muzzle away from you. Place the elongated hole in the rear of the connector assembly on the elongated stud on the rear release (1, fig 16). Place the thumb of the right hand on the rear of the connector assembly, the first finger on the rear release bracket, and the second finger inside the rear of the receiver. Pushing toward the muzzle with the right thumb and with the thumb and first finger of the left hand, turn the front of the connector counterclockwise until it can be snapped onto the connector lock (2, fig 16).

11. Assembly of the Three Main Groups

* Place the barrel and receiver group on a flat surface, sights down. Pick up the stock group and engage the stock ferrule in the front band, then lower the stock group onto the barrel and receiver group.



Figure 15. Replacing the operating rod spring and operating rod spring guide



1
Figure 15 Replacing the connector assembly.



2
Figure 16—Continued

b. Open the trigger guard and place the firing mechanism straight down into the receiver, making sure that the guide rib on the firing mechanism enters the recess in the receiver (fig 17). Place the butt of the weapon on the left thigh, sights to the left, insuring the trigger guard has cleared the trigger. With the palm of the right hand, strike the trigger guard fully engaging it to the receiver.

12. Disassembly of the Gas System and Handguard

Note. Under normal usage the gas cylinder should not be disassembled as long as the gas piston slides freely within the cylinder when the barrel is tilted end-forward from an upright position (butt should be locked to the rear). Disassembly of the gas cylinder is sometimes necessary after the weapon has been subjected to extreme climatic conditions.

a. Gas System. Using the wrench of the combination tool, loosen and remove the gas cylinder plug. Tilt the muzzle down and remove the gas

piston from the gas cylinder. Unscrew the gas cylinder lock and slide the lock and cylinder forward so that the gas port is exposed.

b. Handguard. Slip the front band forward toward the front sight. Push the handguard toward the front sight and lift it from the barrel. The parts of the gas system are shown in figure 18.

13. Assembly of the Gas System and Handguard

a. Handguard. Place the rifle on a flat surface, sights up and muzzle to the right. Engage the ends of the band on the handguard with the front (muzzle) end of the slots that are on the rear of the barrel and slide the handguard rearward. (Do not snap or force the handguard into its installed position.) Replace the front band.

b. Gas System. Slide the gas cylinder rearward through the front band. Tighten the gas cylinder

lock by hand to its fully assembled position, then back it off until the loop is aligned with the gas cylinder. Replace the gas piston with the flat part toward the barrel and the open end toward the muzzle. When the gas piston is properly seated, it

will protrude 3.81 centimeters (1.5 inches) below the gas cylinder (Fig. 19). Replace the gas cylinder plug and tighten it securely with the wrench of the combination tool.



Figure 17. Replacing the firing mechanism

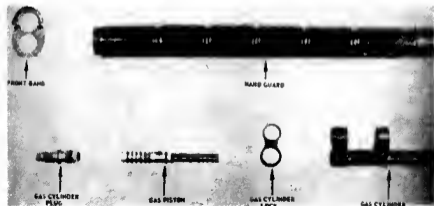

Figure 18. Parts of the gas system. Handguard and front band



Figure 19 Gas piston properly seated

14. Removing Stabilizer Assembly

To remove the stabilizer assembly, use the wrench of the combination tool to loosen the locknut. Then slide the combination tool over the screw and loosen it (fig. 20). Swing the yoke away from the bayonet lug, and slide the stabilizer assembly off the flash suppressor (fig. 21).

15. Replacing Stabilizer Assembly

To replace the stabilizer assembly, slide it over the flash suppressor, swing the yoke over the bayonet lug, and tighten the screw with the combination tool (fig. 21). Slide the combination tool over the head of the screw, place it over the locknut, and tighten it (fig. 20).

16. Disassembly and Assembly of the Magazine

a. Disassembly.

(1) Use a pointed object to raise the rear of the

magazine base (fig. 22) until the indentation on the base is clear of the magazine. Grasp the magazine with either hand, with one finger of the hand covering the base. Remove the base and guide the spring one coil at a time, to clear the retaining lips of the magazine.

(2) Remove and separate the magazine spring and follower. Figure 23 shows the parts of the magazine.

b. Assembly. Reposition the spring inside the follower with the rectangular-shaped end of the spring against the rear of the follower, and replace the follower and spring inside the magazine. Be sure to fully seat the follower. Replace the magazine base (fig. 24).



Figure 20 Removing the stabilizer assembly

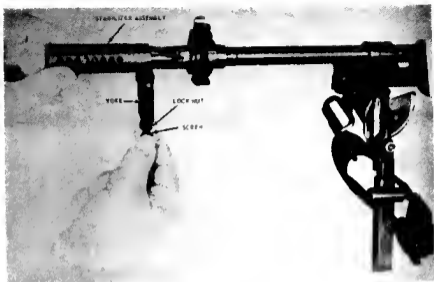

Figure 21. Replacing the stabilizer assembly.



Figure 22. Removing the base of the magazine.

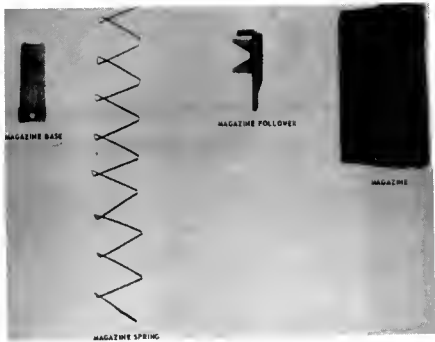

Figure 23. Parts of the magazine.



Figure 26 Replacing the magazine base

Section III. OPERATION AND FUNCTIONING

17. Operation

a. Loading the Magazine (Out of the Rifle).

(1) Place the first round on top of the magazine follower (with the bullet end toward the front of the magazine) and apply pressure with the thumb to fully seat the round in the magazine (fig 24). Place each additional round on the preceding one, seating it in the magazine.

(2) To load the magazine with a live-round

cartridge clip, the magazine filler is used (fig 26). Slide the filler over the top rear portion of the magazine and insert a five-round cartridge clip into the filler. Place either the thumb or the open end of the combination tool on the top round and push the live rounds into the magazine. Remove the clip and repeat the process until 20 rounds have been loaded into the magazine, then remove the magazine filler



Figure 25. Loading the magazine, single round (OUT of rifle).



Figure 26. Loading the magazine using the magazine filler (magazine OUT of rifle).

b. Loading the Magazine (in the Rifle).

(1) To load a single round into an empty magazine in the weapon, lock the bolt to the rear and engage the safety. Place a round on top of the magazine follower and press down on the round and lully seat it in the magazine (fig 27).

(2) A magazine in the weapon can be loaded through the top of the receiver with a five-round

cartridge clip. To do this, place either end of the clip in the cartridge guide, then exert pressure with the thumb or the open end of the combination tool on the top round, forcing five rounds into the magazine (fig 28). Remove and discard the cartridge clip. Repeat the process until the magazine is loaded.

c. Loading and Unloading the Rifle

(1) Place the safety in the safe position.

(2) Insert a loaded magazine into the magazine well, top front first, until the operating rod spring guide engages the magazine (1, fig 29), then pull backward and upward until the magazine snaps into position 12, fig 291. A click will be heard which indicates that the magazine is fully seated.

Pull back and release the operating rod handle, allowing the bolt to strip the top round from the magazine and load it into the chamber.

(3) Remove the magazine as described in paragraph 7.

18. Functioning

a. Semiautomatic.

(1) Each time a round is fired, the parts inside the rifle work together in a given order. This is the cycle of operation. This cycle is similar in all small arms. A knowledge of what happens inside the rifle during the cycle of operation will help the firer to understand the causes of, and remedies for, various stoppages.



Figure 27. Loading the magazine with a single round (magazine IN rifle)



Figure 28 Loading the magazine with a five-round cartridge clip (magazine 1's rifle).



1
Figure 29 Loading the magazine into the rifle.



2
Figure 29—Continued

(2) The cycle of operation is broken down into eight steps. These steps are listed below, together with a brief description of what occurs inside the rifle during each step.

(a) *Firing.* Firing occurs when the firing pin strikes the primer. As the trigger is pulled, the trigger lugs are disengaged from the hammer hooks and the hammer is released. The hammer moves forward under pressure of the hammer spring and strikes the tang of the firing pin, driving the firing pin against the primer and firing the round (fig 30).

(b) *Unlocking.* Unlocking (fig 31) occurs after the firing of the round. As the bullet is forced through the barrel by the expanding gases, a small amount of gas enters the hollow gas piston, the gas cylinder and the gas cylinder plug through the gas port. The expanding gases force the gas cylinder piston to the rear. It in turn drives the operating rod and bolt rearward. The operating rod cams the bolt roller upward, disengaging the locking lugs on the bolt from the locking recesses in the receiver. At this time, the bolt is unlocked.

Note. The spindle valve must remain in the open position (the slot in the spindle head perpendicular to the

barrel) during all firing, except when launching a grenade (fig 32).

(c) *Extracting.* Extracting is pulling the empty cartridge from the chamber. Slow initial extraction takes place as the bolt unlocks. The bolt in its rearward motion pulls the empty cartridge with it (fig 33).

(d) *Ejecting.* Ejecting is removing the empty cartridge from the receiver. As soon as the bolt has withdrawn the empty cartridge case clear of the chamber, the force of the ejector spring and plunger pushes the bottom edge of the cartridge base away from the bolt face, throwing it out and away from the receiver (fig 34).

(e) *Cocking.* Cocking is positioning the hammer so that it is ready to fire the next round. The bolt, as it moves to the rear, forces the hammer down and rides over it. The hammer is caught by the sear if the trigger is held to the rear and by the trigger lugs if the trigger has been released (fig 34). In either case, the hammer is held in the cocked position.

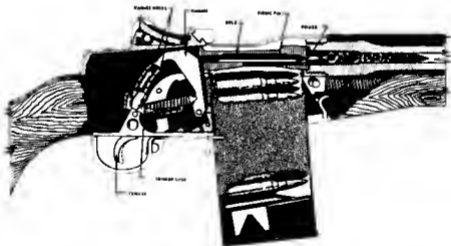

Figure 30. Firing.

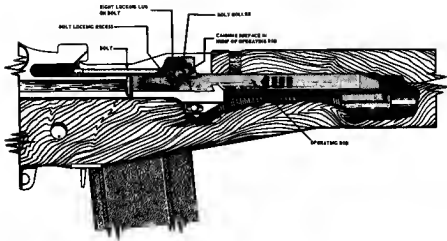

Figure 31. Unlocking.



TOP STANDARD AMMUNITION SEMI-AUTOMATIC AND
AUTOMATIC FIRE

BOTTOM FOR FIRING GRENADES

Figure 32. Positions of the spindle valve

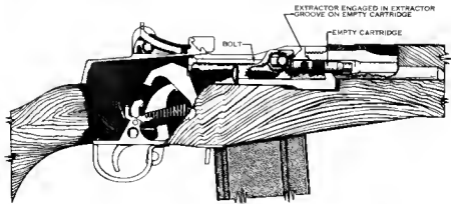

Figure 33. Extracting

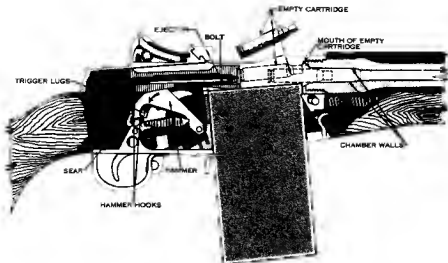

Figure 34 Ejecting the last round and cocking.

(f) *Feeding.* Feeding takes place when a round is forced into the path of the bolt. The top round is forced into the path of the bolt by the magazine follower which is under pressure of the magazine spring (fig 35). After the last round has been fired, the bolt is held in the rearward position by the bolt lock.

(g) *Chambering.* Chambering occurs when a round is moved into the chamber. This takes place as the bolt goes forward under pressure of the expanding operating rod spring, stripping the top round from the magazine and driving it forward into the chamber (fig 36). Chambering is complete when the extractor snaps into the extracting grooves on the cartridge and the selector is compressed into the face of the bolt.

(h) *Locking.* Locking begins as the bolt roller engages the rear camming surface in the hump of the operating rod. It is completed when the locking lugs of the bolt are fully seated in the locking recesses of the receiver (fig 37).

b. Automatic (Rifles Equipped with Selector).

(1) When the selector is positioned with the face marked "A" in the rear leaf type projection up), the rifle is set for automatic fire. Turning the selector to automatic rotates the sear release in position to make contact with the sear.

(2) After the first round has been fired (and with the trigger held to the rear), the operating rod starts its rearward movement under pressure of the expanding gases. As it moves to the rear, the connector assembly moves rearward under pressure of the connector assembly spring. The movement of the connector assembly rotates the sear release on the selector shaft so that the flange on the sear release allows the sear to move forward into a position where it can engage the rear hammer hooks (fig 38). Then, when the bolt drives the hammer to the rear, the sear engages the rear hammer hooks and holds the hammer in the cocked position.

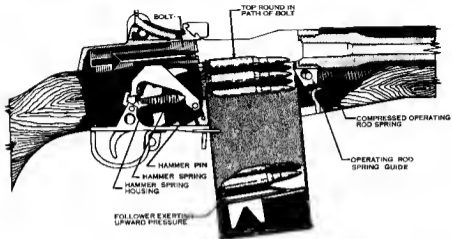

Figure 35. Feeding.

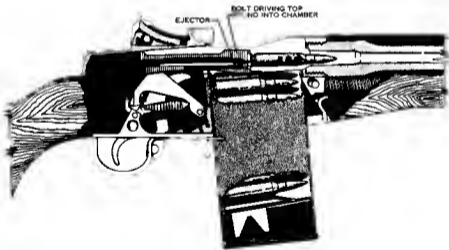

Figure 36 Chambering.

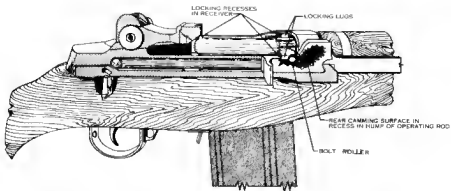

Figure 37. Locking

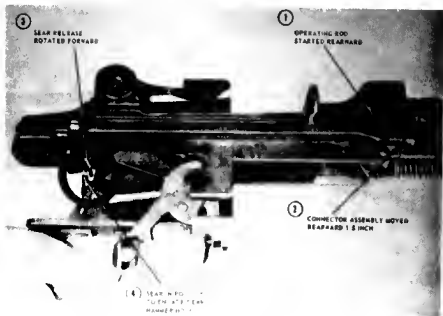
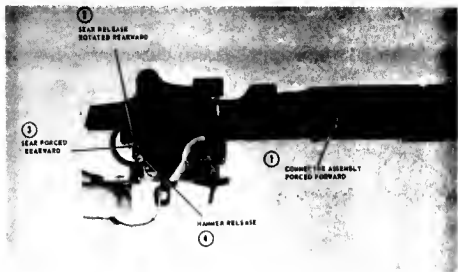

Figure 38. Actions of the connector assembly and its effects on the firing mechanism during automatic firing

131 After the bolt moves forward and locks, the shoulder on the operating rod engages the hook of the hammer assembly and forces it forward. This rotates the sear release on the selector shaft, causing the flange on the sear release to push the sear to the rear, disengaging it from the rear

hammer hook 12, fig 381. The hammer will then go forward if the trigger is held to the rear. If the trigger is released at any time prior to the firing of the last round, the hammer will be held in the cocked position by the trigger lugs.



2

Figure 38-4 continued

Section IV. STOPPAGES AND IMMEDIATE ACTION

19. Stoppages

a. *Definition.* A stoppage is an unintentional interruption of the cycle of operation. The stoppage may be caused by improper functioning of the rifle or faulty ammunition.

b. Types of Stoppages

(1) *Misfire.* A misfire is a failure to fire. A misfire itself is not dangerous, but since it cannot be immediately distinguished from a delay in the functioning of the firing mechanism, it should be considered as a possible delay in firing until this possibility has been eliminated. A delay in the functioning of the firing mechanism could result from the presence of foreign matter such as sand, grit, oil and grease. These might create a partial mechanical restraint which, after some delay, is

overcome by continued force applied by the spring, and the firing pin then strikes the primer. No round should be left in a hot weapon any longer than necessary because of the possibility of a cookoff.

(2) *Cookoff.* Cookoff is the functioning of a chambered round of ammunition initiated by the heat of the weapon. If the primer or propelling charge should cookoff, the projectile will be propelled from the weapon with normal velocity even though no attempt was made to fire the primer by actuating the firing mechanism. One hundred and fifty rounds fired in a 2-minute interval will heat the barrel enough to produce a cookoff.

c. *Common Stoppages.* The rifle will function efficiently if it is properly maintained. The firer must watch for defects and correct them before they

cause a stoppage. Some of the more common stoppages, their usual causes and remedies, are shown in chart 2.

Chart 2. Stoppages: Their Causes and Remedies

Stoppages	Causes	Remedy
Failure to feed	Defective or worn parts	Replace parts.
	Dirty or dented magazine	Clean or replace magazine.
Failure to chamber	Loose gas cylinder plug	Tighten plug.
	Lack of lubrication of operating parts	Clean and lubricate parts
	Dirty chamber	Clean chamber.
Failure to lock	Defective ammunition	Replace ammunition.
	Lack of lubrication of operating parts	Clean and lubricate parts.
Failure to fire	Dirty locking recesses	Clean recesses
	Weak operating rod spring	Replace spring.
	Defective ammunition	Replace ammunition
	Broken firing pin	Replace firing pin.
Failure to unlock	Defective or broken parts in firing mechanism	Replace parts or entire firing mechanism.
	Bolt not fully locked	See Failure to lock.
	Dirty chamber	Clean chamber.
	Lack of lubrication of operating parts	Clean and lubricate parts.
Failure to extract	Insufficient gas	Tighten gas cylinder plug and check spindle valve.
	Spindle valve closed	Open valve.
	Dirty chamber	Clean chamber.
Failure to eject	Dirty ammunition	Replace ammunition.
	Broken extractor	Replace extractor.
Failure to cock	Broken ejector or weak ejector spring	Replace faulty part.
	Defective or broken parts in firing mechanism	Replace parts or entire firing mechanism.

20. Immediate Action

Immediate action is the unhesitating application of a probable remedy to reduce a stoppage without investigating the cause. Immediate action is taught in two phases.

a. The first phase is taught as a drill so that the rifleman learns to perform it quickly and instinctively without thought as to the cause of the stoppage. To apply the first phase: with the right hand, palm up, pull the operating rod handle all the way to the rear. Release it, aim and attempt to fire. The palm is up to avoid injury to the hand in event of a cochoff (fig 39).

b. If the first phase of immediate action fails to

reduce a stoppage, the second phase of immediate action is applied. The five key words to remember in the second phase are: TAKE, PULL, LOOK, LOCATE, and REDUCE.

111 TAKE the rifle from the shoulder.

121 PULL the operating rod handle slowly to the rear.

131 LOOK in the receiver.

141 LOCATE the stoppage by observing, as the operating rod handle is pulled to the rear, what is in the chamber, and what has been ejected.

151 REDUCE the stoppage and continue to fire.



Figure 39 Applying immediate action

2. Misfires will rarely occur. Normally, the firer will instinctively apply immediate action which in most instances reduces the stoppage even when caused by a hangfire or misfire. The normal cause

of a misfire is faulty ammunition. Therefore, further use of ammunition from that lot should be suspended and reported to ordnance for disposition.

Section V. MAINTENANCE

21. General

Maintenance includes all measures taken to keep the rifle in operating condition. This includes normal cleaning, inspection for defective parts, repair and lubrication.

22. Cleaning Materials, Lubricants, and Equipment

a. Cleaning Materials.

(1) Bore cleaner (cleaning compound solvent [CR]) is used primarily for cleaning the bore; however, it can be used on all metal parts for a temporary (1 day) protection from rust.

(2) Hot, soapy water or plain hot water is no substitute for bore cleaners and will only be used when bore cleaner is not available.

(3) Dry cleaning solvent (SD) is used for cleaning rifles which are coated with grease, oil, or corrosion preventive components.

(4) Carbon removing compound (P-C-111-A) is used on stubborn carbon deposits by soaking and brushing. This process must be followed by the use of dry cleaning solvent.

b. Lubricants

(1) Lubricating oil, general purpose (PL special), is used to lubricate the rifle at normal temperature.

(2) Lubricating oil, weapons (LAW), is used for low temperatures (below 0°).

(3) OE 10 engine oil may be used as a field expedient under combat conditions when the oils prescribed in (1) and (2) above cannot be obtained. However, as soon as possible the weapon should be cleaned and lubricated with the proper, authorized lubricants.

(4) Rifle grease should be applied to those working surfaces shown in figure 40.

• *Equipment.*

(1) A complete set of maintenance equipment (fig 41) is stored in the stock of the M14 rifle.

(2) The combination tool can be used as either a 20 degree offset screwdriver or as a gas plug wrench (figs 42 and 43).

(a) The handle of the combination tool is also used as the cleaning rod handle. Allow the cleaning rod extension of the tool to fall from the tool handle so that it hangs perpendicular. Assemble the four sections of the cleaning rod and screw them into the threaded hole in the cleaning rod extension. Either the bore brush or the cleaning patch holder may be attached to the end of the cleaning rod.

(b) The plastic lubricant case (fig 44) is closed with a screw cap which has a stem applicator attached at one end that is used to apply oil drop by drop. The cap is fitted with a gasket to prevent oil leakage. The other end has another screw cap with applicator and contains rifle grease.

23. *Cleaning the Rifle.*

a. *Procedures for Cleaning Chamber and Bore.*
The rifle must be cleaned after it has been fired because firing leaves primer fouling, powder ashes, carbon, and metal fouling. The ammunition has a noncorrosive primer which makes cleaning easier, but not less important. The primer still leaves a deposit that may collect moisture and promote rust if it is not removed.

(1) Immediately after firing, thoroughly clean the bore with a bore brush saturated with CR, solvent cleaning compound.

(2) After cleaning with CR, the bore should be swabbed with Hannel cleaning patches making certain no trace of burned powder or other foreign substances are left. Then apply a light coat of PL special, general purpose lubricating oil.

(3) The chamber should be cleaned with a cleaning brush, using the following procedures:



1
Figure 40 Points to apply rifle grease.

LOCKING MECHANISM

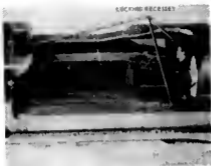

BOLT
NUT



2
Figure 40—Continued

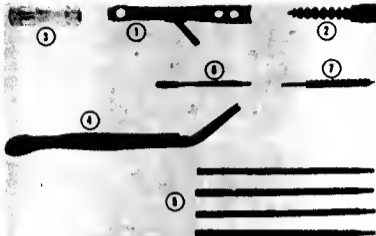

1- COMBINATION TOOL.

2- CHAMBER CLEANING BRUSH.

(INSURE THE M14 CHAMBER BRUSH IS USED TO PREVENT BARREL DAMAGE THE M14 BRUSH IS ONE-HALF INCH SHORTER THAN THE M1 CHAMBER BRUSH.)

3- PLASTIC CASE LUBRICANT.

4- SMALL ARMS CLEANING ROD CASE.

5- SMALL ARMS CLEANING ROD SECTION (4 EACH).

6- CLEANING PATCH HOLDER.

7- SMALL ARMS BORE CLEANING BRUSH.

Figure 41 Maintenance equipment

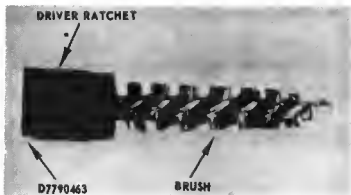

2
Figure 41—Continued

COMBINATION TOOL

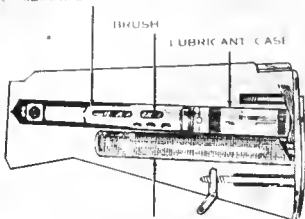

CASE CLEANING ROD
CONTAINING 4 SECTIONS
1 BRUSH
1 HOLDER

3
Figure 41—Continued



Figure 12 Combination tool used as a srouddrver.



Figure 11 Combination tool used as a screw



Figure 44 Plastic lubricant case.

(a) Screw the threaded end of cleaning rod section into ratchet base of brush (1A, fig 45).

(b) Apply a light coat of CR to chamber.

(c) Insert brush in chamber with thumb pushing against base of brush (1B, fig 45).

(d) Release the bolt lock and ease operating rod and bolt forward, seating brush in chamber. If rifle is disassembled, continue to apply pressure to rear of brush with thumb.

(e) Move rod section from side to side several times (1C, fig 45).

(f) Lock the bolt to the rear and remove the brush while grasping the cleaning rod section as shown in 1D, figure 45.

(4) Continue to clean and lubricate the bore and the chamber, applying a light coat of PL special, as shown in figure 45 and figure 46.

b. Gas Cylinder Plug Pour a small quantity of bore cleaner in the plug, insert and rotate the bore

cleaning brush. Remove the brush, clean, and dry the plug with patches.

c. Gas Cylinder. Install the patch holder on a section of the cleaning rod. Put two patches in the holder, moisten them with bore cleaner, and swab the cylinder bore. Dry the cylinder bore with clean patches. Use no abrasives in cleaning the cylinder and do not oil the interior surfaces.

d. Gas Piston. Saturate patches with bore cleaner and wipe the exterior surface of the piston as clean as possible. Install the bore cleaning brush on a section of the cleaning rod. Moisten the brush with bore cleaner and clean the interior of the piston. Wipe the piston dry, but do not oil. The gas system incorporates a self-cleaning section and functions within very close tolerances. A piston does not have to be shiny to function properly. Do not use abrasives to clean the piston.

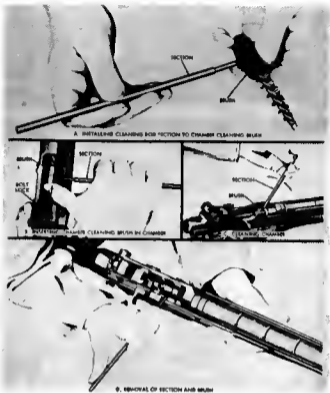
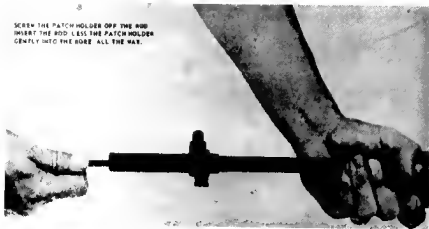

Figure 45. Cleaning the chamber

3 7

SCREEN THE PATCH HOLDER OFF THE ROD
INSERT THE ROD LESS THE PATCH HOLDER
GENTLY INTO THE BORE ALL THE WAY.



1
Figure 46. Cleaning the bore.

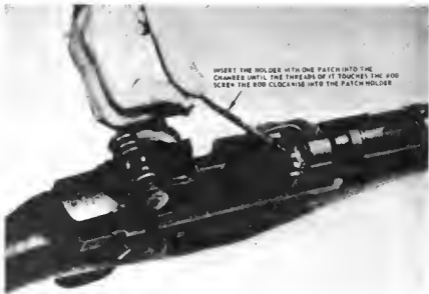

INSERT THE HOLDER WITH ONE PATCH INTO THE CHAMBER UNTIL THE THREADS OF IT TOUCHES THE ROD. SCREW THE ROD CLOCKWISE INTO THE PATCH HOLDER.

2
Figure 46—Continued



PULL PATCH THROUGH BORE IN STRAIGHT LINE WITH AXIS OF BORE AND OUT THE MUZZLE.

3
Figure 46—Continued

c. *Face of the Bolt.* Clean the face of the bolt with a patch and bore cleaner, paying particular attention to its inside edges. Remove the bore cleaner with dry patches and oil the part lightly.

f. *Spindle Valve.* Depress the valve and rotate it several times after each day's firing. Do not disassemble it.

g. *Magazine.* Inspect the interior of the magazine by depressing the follower with the thumb. If the interior is dirty, disassemble the magazine and clean it, then lightly oil the component parts. Otherwise, merely wipe the magazine assembly clean and dry, then oil it.

h. *Stabilizer Assembly.* The stabilizer assembly should be removed and cleaned with a stiff brush to remove all carbon or other particles which may block the gas ports.

i. *All Other Parts.* Use a dry cloth to remove all dirt or sand from other parts and exterior surfaces. Apply a light coat of oil to the metal parts and rub raw linseed oil into the wooden parts. Care must be taken to prevent linseed oil from getting on metal parts.

j. *After Firing.* The rifle must be thoroughly cleaned the same day it is fired. For three consecutive days thereafter, check for evidence of fouling by running a clean patch through the bore and inspecting it; clean the rifle if fouling is found. The bore should be lightly oiled after each inspection.

24. Normal Maintenance

a. The rifle should be inspected daily, when in use, for evidence of rust and general appearance. A light coat of oil should be maintained on all metal parts, except the gas piston, interior of the gas cylinder, and the gas plug.

b. The daily inspection should also reveal any defects such as burrs, worn or cracked parts. Defects should be reported to the armorer for correction.

c. A muzzle plug should never be used on the rifle. It causes moisture to collect in the bore, forming rust and creating a safety hazard.

d. Obtaining the proper rear sight tension is extremely important; without it, the sight will not hold its adjustment in elevation. During normal maintenance, and prior to firing, the rear sight must be checked for correct sight tension. The indications of improper sight tension are:

(1) Elevation knob extremely difficult to turn.

(2) Elevation knob turns freely without an audible click.

(a) If the elevation knob is extremely difficult to turn, rotate the windage knob nut counterclockwise one click at a time with the screwdriver portion of the combination tool. After each click attempt to turn the elevation knob. Repeat this process until the elevation knob can be turned without extreme difficulty (1, fig 47).

(b) If the elevation knob is extremely loose and the rear sight aperture will not raise, the windage knob nut must be turned in a clockwise direction, one click at a time, until the aperture can be raised.

e. To check for proper tension, the procedures listed below should be followed:

(1) Raise the aperture to its full height.

(2) Lower the aperture two clicks.

(3) Grasp the rifle with the fingers around the small of the stock and exert downward pressure on the aperture with the thumb of the same hand (2, fig 47).

(4) If the aperture drops, sight tension must be adjusted. To do this, the windage knob nut must be tightened, one click at a time, until the aperture can no longer be pushed down. If the proper tension cannot be obtained, the rifle must be turned into the unit armorer.

25. Special Maintenance

a. Before firing the rifle, the bore and the chamber should be cleaned and dried. A light coat of oil should be placed on all other metal parts, except those which come in contact with ammunition, the gas piston, interior of the gas cylinder, and the gas plug.



1
Figure 47 Adjusting night vision



2

Figure 47—Continued

b. Before firing, rifle grease should be applied to the parts indicated in figure 40. A small amount of grease is taken up on the stem of the grease container cap and is applied at each place. Rifle grease is not used in extremely cold temperatures or when the rifle is exposed to extremes of sand and dust.

c. In cold climates (temperatures below freezing) the rifle must be kept free of moisture and excess oil. Moisture and excess oil on the working parts cause them to operate sluggishly or fail completely. The rifle must be disassembled and wiped with a clean cloth. Dry cleaning solvent may be used if necessary to remove oil or grease. Parts that show signs of wear may be wiped with a patch lightly dampened with lubricating oil (LAW). It is best to keep the rifle as close as possible to outside temperatures at all times to prevent the collection of

moisture which occurs when cold metal comes in contact with warm air. When the rifle is brought into a warm room, it should not be cleaned until it has reached room temperature.

d. In hot, humid climates, or if exposed to salt water atmosphere, the rifle must be inspected thoroughly each day for moisture and rust. It should be kept lightly oiled with general purpose lubricating oil. Raw linseed oil should be frequently applied to the wooden parts to prevent swelling.

e. In hot, dry climates, the rifle must be cleaned daily or more often to remove sand and/or dust from the bore and working parts. In sandy areas, the rifle should be kept dry. The muzzle and receiver should be kept covered during sand and dust storms. Wooden parts must be kept oiled with raw linseed oil to prevent drying. The rifle should

be lightly oiled when sand or dust conditions decrease.

f. Special instructions on caring for the rifle

when it is subject to nuclear, biological, or chemical contamination can be found in TM 3-220 and FM 21-40.

Section VI. AMMUNITION

26. General

The M14 rifle fires several types of ammunition. The rifleman should be able to recognize them and know which type is best for certain targets. He should also know how to care for the ammunition.

a. Figure 48 shows the parts of a typical cartridge.

b. The term "bullet" refers only to a small arms projectile; the term "ball" was originally used to describe the ball-shaped bullet of very early small arms ammunition. The term "ball ammunition" now refers to a cartridge with a general purpose solid-core bullet intended for use against personnel and material targets.

27. Description

The types of ammunition can be identified by their individual markings (fig 49).

a. *Armor Piercing.* The M61 armor piercing cartridge is used against lightly armored targets. The cartridge can be identified by its black tip.

b. *Ball.* M80 ball ammunition is used against personnel and unarmored targets. The cartridge can be identified by its unpainted tip.

c. *Tracer.* The M62 tracer cartridge is used for indicating target areas and adjusting fire. The cartridge can be identified by its orange tip.

d. *Grenade Cartridge.* The M64 rifle grenade cartridge is used for launching grenades and pyrotechnics. The cartridge can be identified by its five-pointed, star-crimped end.

e. *Blank.* The M82 blank cartridge is used to add realism to training. It can be identified by its long narrow neck.

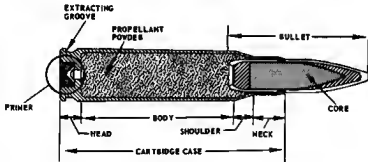

Figure 48. Parts of a cartridge.

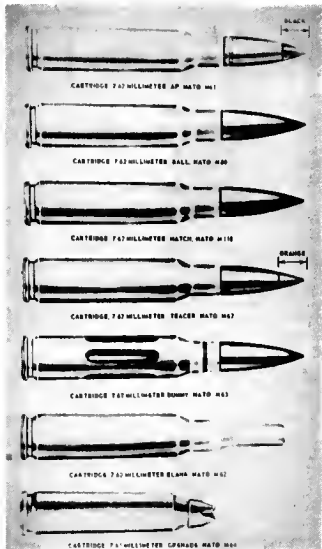

Figure 49. Types of ammunition for the M74 and M14A1 rifles.

f. *Dummy*. The M63 dummy cartridge has six longitudinal corrugations approximately one-third the length of the case. There are no markings on the bullet and there is no primer in the base of the cartridge. It is used in training for dry firing exercises.

g. *Match*. The M118 match cartridge is used in competitive firing. Because of its increased accuracy, it is also used for sniper missions. The M118 cartridge can be identified by the word "MATCH" inscribed on its base.

28. Packaging

a. *The 5-Round Cartridge Clip*. Ammunition is prepacked in five-round cartridge clips. Twelve clips are packed in a cloth headcase. Seven headcases are packed in a can and two cans are packed in a case.

b. *The 20-Round Carton*. Ammunition is also

packed in 20-round cartons. Twenty-three cartons are packed in a can and two cans are packed in a case.

c. *Magazine Filler*. The magazine filler is an adapter which fits over the top of an empty magazine (when the magazine is not in the weapon) and makes it easier to load. One magazine filler is packed in each case of ammunition.

29. Care, Handling, Preservation

a. Care should be taken to prevent ammunition boxes from becoming broken or damaged.

b. Ammunition should not be exposed to the direct rays of the sun. If the powder is heated, excessive pressure may develop. This condition will affect ammunition performance and create a safety hazard.

c. Ammunition should be kept clean and dry.

Section VII. ACCESSORIES

30. M2 Bipod

The M2 bipod (fig 50) is a light, folding mount which clamps onto the gas cylinder and gas cylinder lock of the rifle.

a. *Installation* (fig 51). Place the jaws of the yoke assembly so that they encircle the gas cylinder at the gas cylinder lock. Tighten the self-locking bolt with the combination tool, securing the jaws to the gas cylinder.

b. *Removal*. Using the combination tool, loosen the bolt located beneath the yoke assembly and remove the bipod from the rifle.

31. M6 Bayonet Knife and M8A1 Bayonet Knife Scabbard

The M6 bayonet knife (fig 52) is utilized for close combat, guarding prisoners, and riot control. The M8A1 bayonet scabbard is used to carry the bayonet knife.

a. *Installation*. Install the bayonet knife to the rifle by aligning the groove of the bayonet handle with the bayonet lug on the flash suppressor and the loop at the top portion of the handle on the flash suppressor. Slide the knife rearward until the lugs

of the latching lever snap over the bayonet lug (fig 53).

b. *Removal*. Grasp the handle of the bayonet and depress the latching lever on the handle, releasing the bayonet lug from the groove in the handle. Slide the bayonet from the rifle.

32. M76 Grenade Launcher

The M76 grenade launcher (fig 54) is attached to the barrel of the rifle for launching grenades. The barrel of the launcher contains nine annular grooves, numbered 6 to 1, 2A, 3A, and 4A. When firing grenades, these are utilized to obtain different ranges by placing the grenade at different positions on the launcher. On the bottom portion of the muzzle end of the launcher there is a clip-type retainer spring used to hold the grenade on the launcher at the desired position prior to firing. The unmarked groove located above the retainer spring is a safety groove that prevents the grenade from slipping off the launcher if the retainer clip breaks. When using the grenade launcher, the spindle valve MUST be in the OFF (parallel to barrel) position.

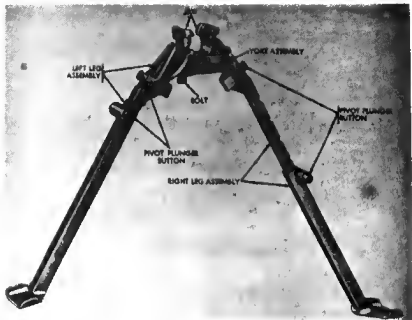

Figure 50 M2 bipod



Figure 51 Installation of M2 bipod

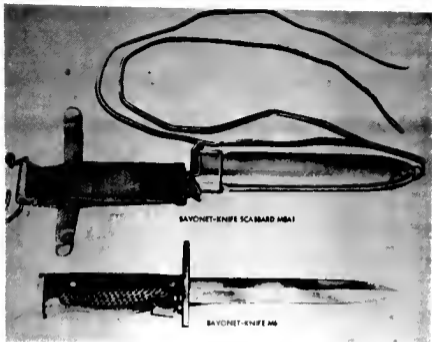

Figure 52. M5 bayonet knife and M8A1 bayonet scabbard.



Figure 53. M14 rifle with bayonet knife.

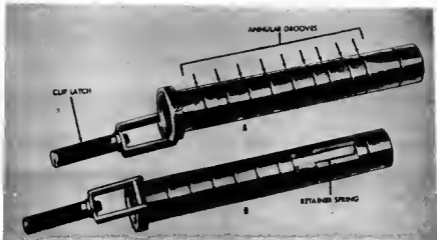

Figure 54. M76 grenade launcher.

a. *Installation.* To install the grenade launcher, slide the launcher over the flash suppressor. Push the clip latch rearward, securing it to the bayonet lug of the flash suppressor (fig 55).

b. *Removal.* To remove the grenade launcher pull downward on the handle of the clip latch, releasing it from the bayonet lug on the flash suppressor, and slide the launcher from the flash suppressor.

33. M15 Grenade Launcher Sight

The grenade launcher sight provides an angular measurement of elevation for firing grenades and can be used for both low angle (direct firing) and high angle firing.

a. *Installation.* Install the sight to the mounting

plate, aligning notches of the plate with the click spring tips of the sight (fig 56). Turn sight clockwise until the index line is aligned with the 0 degree index on the mounting plate. At this position, the leveling bubble should be level. If the bubble cannot be leveled, the rille should be turned in to the unit armorer.

b. *Removal.* Turn sight counterclockwise until the tips of the clip springs are aligned with the notches in the mounting plate; remove the sight from the mounting plate (fig 56). When not in use, the sight should be left in its carrying case.

Note. Removal and mounting of the mounting plate is accomplished by support maintenance personnel ONLY.



Figure 55. M14 rifle with M76 grenade launcher



Figure 56. Installation of M15 grenade launcher sight

34. M12 Blank Firing Attachment and Breech Shield

The blank firing attachment and breech shield (fig 57) are designed for use when firing blank cartridges. The blank firing attachment consists of an orifice tube and a spring clip latch which secures the attachment to the bayonet lug of the flash suppressor. The breech shield is used with the blank firing attachment and consists of a deflector shield and a guide lug with spring plunger which secures the shield to the cartridge clip guide.

a. Installation (fig 58).

(1) *Blank firing attachment.* Insert the orifice tube in the muzzle opening of the flash suppressor. Pull out on the clip latch and push down on the top of the orifice tube of the blank firing attachment. Release the clip spring latch securing the cut away portion of the latch to the bayonet lug.

(2) *Breech shield.* Insert the guide lug of the breech shield into the slot of the cartridge clip guide. Using any empty blank cartridge, press in on

the spring plunger and push down on the breech shield, locking it to the cartridge clip guide.

b. Removal

(1) *Blank firing attachment.* In removing the blank firing attachment from the rifle, pull outward on the spring clip latch, releasing it from the bayonet lug. Turn the attachment either to the left or the right of the bayonet lug and slide the attachment from the flash suppressor.

(2) *Breech shield.* Using an empty blank cartridge, or any suitable object, press in on the spring plunger located on the guide lug of the breech shield. Lift the breech shield from the cartridge clip guide.

35. Winter Trigger Kit

The winter trigger kit (fig 59 and 60) is utilized during cold weather and arctic operations by special authorization of the theater commander. It consists of two woodscrews, a winter trigger assembly, and a winter safety. The safety can be

easily operated by the firer while wearing heavy gloves or mittens because of its long protruding tang which extends approximately 1½ inches below the firing mechanism.

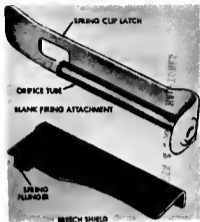

*Figure 57. M12 blank firing attachment and
M3 breach shield*



Figure 58. Installation of blank firing attachment and breech shield

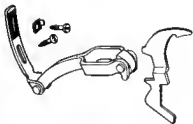

Figure 59. Winter trigger kit



Figure 60. M14 rifle with winter trigger kit installed

RIFLE MARKSMANSHIP FUNDAMENTALS

Section I. GENERAL

36. Purpose and Scope

To be proficient, a combat rifleman must be able to detect targets, determine the ranges to targets, and hit the targets when he fires at them. There are many variables affecting an individual's ability to detect and determine the ranges to combat targets (chap 6). However, the factors affecting a rifleman's ability to fire and hit the target are relatively constant. Essentially, the rifleman must be able to assume a firing position which enables him to hold the rifle in such a manner that he and his rifle form a single, steady unit. He must know how to correctly align his rifle on the target and he must be able to fire his rifle without disturbing this alignment. The skills needed to accomplish these requirements are known collectively as rifle marksmanship fundamentals.

37. Early Firing Exercise and Recoil Demonstration

A recoil demonstration and an early-firing exercise should be conducted for soldiers who have little or no previous marksmanship experience. The recoil demonstration will clearly show soldiers that they have nothing to fear from recoil if they handle the weapon properly. The early firing exercise is designed to motivate soldiers toward marksmanship training.

a. *Recoil Demonstration.* A recoil demonstration should be conducted before the soldier fires the

service rifle for the first time. The demonstration is fired by a well-trained rifleman. He fires the first round while holding the rifle to his side, in one hand. Next, he fires a round while holding the butt of the weapon tightly against his thigh. The third round is fired with the rifle butt pressed firmly against the demonstrator's groin. A fourth round is fired with the butt of the rifle placed firmly against the pit of the stomach. The final round will usually convince even the most skeptical, since it is fired with the rifle butt pressed firmly against the demonstrator's chin. As long as the demonstrator keeps the rifle butt pressed firmly against his body, he will have no difficulty in performing the demonstration. The soldiers should be instructed in the principle of pressing the butt firmly against the body to avoid the effects of recoil.

b. *Early Firing Exercises.* After receiving a brief orientation on range procedures, safety, and the prone position, each soldier fires three rounds at a 25-meter target. When all soldiers have completed firing, they are assembled at a central location to witness a well-trained rifleman fire nine rounds at a 25-meter target within a time period shorter than the time allowed for each soldier to fire his three rounds. By comparing their targets with that of the well-trained rifleman, the need for further marksmanship training will become obvious.

Section II. MARKSMANSHIP FUNDAMENTALS

38. The Integrated Act of Shooting

The integrated act of shooting is the application of the skills necessary to fire a rifle accurately. The components of the integrated act of shooting are aiming and steady hold.

a. *Aiming.*

(1) *Sight picture.* In aiming, the firer is concerned with correctly pointing his rifle so the projectile will hit the target when he fires. To do this, he must have the rear sight, the front sight blade and the target, or aiming point, in their proper relationship—known as sight picture. A correct sight picture is obtained when the sights are perfectly aligned and the aiming point (target) is in

the correct relationship to the front sight blade (fig 6-1). Sight picture includes two basic elements: sight alignment, and placement of the aiming point.

(a) *Sight alignment.* To obtain correct sight alignment, the sights are aligned as shown in figure 6-2. Notice that the top center of the front sight blade is exactly in the center of the rear sight aperture. If an imaginary horizontal line were drawn through the center of the rear sight aperture, the top of the front sight blade would touch this line. If an imaginary vertical line were drawn through the center of the rear sight aperture, the line would bisect the front sight blade. The firer insures that he has perfect sight alignment by



Figure 61. Correct sight picture.



Figure 62. Correct sight alignment.

concentrating his attention and focusing his eye on the front sight blade through the indistinct or fuzzy appearing rear sight aperture. By doing this any errors in sight alignment can be easily detected and corrected.

(b) *Placement of the aiming point.* The aiming point (target on which the firer has lined his rifle sights) is correctly placed when it is centered and appears to touch the top of the front sight blade. If the aiming point is correctly positioned, an imaginary vertical line drawn through the center of the front sight blade will appear to cut it in half (fig 63).

121 *Importance of sight alignment.*

(a) At some point in his marksmanship training, a soldier may experience difficulty in hitting the target because of errors in aiming. The trouble may be either incorrect sight alignment or improper placement of the aiming point. If the firer understands the principles of aiming, he will rarely commit both errors simultaneously. The reason for this lies in the firer's inability to focus his eye on two objects at different distances at the same time. If the firer focuses his eye on the aiming point, the rifle sights will appear hazy and indistinct; therefore, the problem is whether sight alignment or placement of the aiming point is of the greater importance to the firer. An error in either can cause the projectile to miss the aiming point (fig 64). Sight alignment is the relationship between the front and rear sights with respect to the firer's eyes. An error in sight alignment will result in an error that increases proportionately as the range to the target increases. On the battlefield, a near miss as a result of an error in placement of the aiming point can be as effective as a point-of-aim hit. For example, a soldier is approximately 20 inches wide. Consequently, a rifleman could be several inches off his desired aiming point (center of visible mass) and still hit an enemy soldier. However, if the error was due to sight alignment, the bullet would miss a man-size target by as much as several feet, depending on the range. The correct relationship between the front sight blade and the rear sight aperture (sight alignment) is much more important than the placement of the aiming point. Figure 64 depicts some common errors in aiming and the resulting impact of the projectile.



Figure 63. Correct placement of the aiming point.

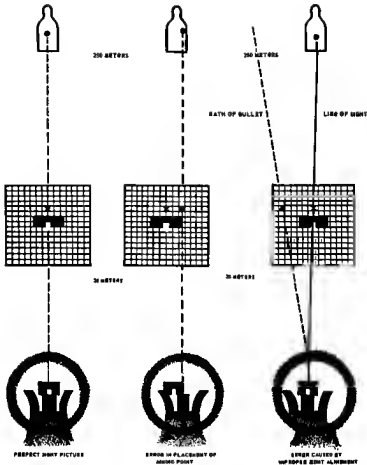

Figure 54. Importance of correct sight alignment.

(b) Since it is so important to obtain and hold perfect sight alignment when shooting, the rifleman must concentrate on it as the first and last steps in aiming. That is, he first concentrates on getting perfect sight alignment, then establishes the proper placement of the aiming point to complete the sight picture, and finally, as he starts to squeeze the trigger, he again concentrates on maintaining perfect sight alignment. At no time during the trigger squeeze should the firer divert his con-

centration from the front sight blade and maintaining perfect sight alignment. With practice, these three steps will become an almost continuous, automatic process. No matter how quickly they are done, the three steps are always distinct for the simple reason that the human eye can focus at *only one distance* and on *only one point* at a time. Therefore, the firer focuses first on the front sight blade to obtain perfect sight alignment, then focuses on the placement of the aiming point to

complete the sight picture by shifting or adjusting the position of the weapon as necessary, and finally, as he starts to squeeze the trigger, he devotes total concentration back to the front sight blade and maintaining sight alignment. At this point the firer should see a picture similar to the one shown in figure 61. Notice that the front sight blade stands out clear and distinct while the aiming point and rear sight aperture are slightly fuzzy or blurred.

b. *Steady Hold Factors.* As the name implies, steady hold is the technique of holding the rifle as steady as possible while aiming the sights and firing the weapon. There are eight factors which affect holding a rifle steady. These factors are the same for all firing positions; however, the precise manner in which they apply differs slightly with the various positions.

Note. Neither the knled shoulder rest nor the sling is used. Experience has proven that the soldier will seldom have, or take, time to adjust either in combat.

(1) *Grip of the left hand.* The rifle should lie across the heel of the left hand and rest in the "V" formed by the thumb and forefinger. The grip on the rifle should be relaxed but, at the same time, exerting a slight rearward pressure. The rifle is held at a point which cuts both the conformation of the firer's body and the location of the target. If the target is high, the left hand is moved closer to the body thereby raising the muzzle of the rifle. Conversely, if the target is low, the left hand is moved forward causing a corresponding drop in the muzzle of the rifle. The left wrist should be as straight as possible. The left elbow should be directly under the receiver of the rifle or as close to this position as the conformation of the firer's body will permit. With the left elbow directly under the rifle, the bones (rather than the muscles) of the arm

support the rifle's weight. The farther away from this position the elbow is located, the greater will be the muscular effort needed to support the rifle. The resulting tensed muscles cause trembling and a corresponding movement of the rifle. However, firers must avoid excessive muscular strain in positioning the elbow as this will also cause trembling. Consequently, inexperienced firers must of necessity undergo a trial and error period until they find the position best suited for them.

(2) *Rifle butt in the pocket of the shoulder.* The firer must place the rifle butt firmly into the pocket formed in the right shoulder. The proper placement of the butt lessens the effect of recoil, helps steady the rifle, and prevents the rifle butt from slipping on the shoulder during firing.

(3) *Grip of the right hand.* The firer's right hand should grip the small of the stock firmly, but not rigidly. A firm rearward pressure must be exerted by the right hand to keep the rifle butt in its proper position in the pocket of the shoulder and to keep it secure enough against the shoulder to reduce the effects of recoil. The thumb extends over the small of the stock in order to enable the firer to obtain a spot weld. The trigger finger should be positioned on the trigger so there is no contact between the finger and the side of the stock (fig 65). This permits the trigger to be pressed straight to the seat without disturbing the firer's aim of the rifle.

(4) *Right elbow.* The placement of the right elbow provides balance to the firer's position. Correctly positioned, the elbow helps form a pocket in the shoulder for the rifle butt. The exact location of the right elbow varies in each position and will be described in the explanation of each position.



Figure 65. Correct trigger finger position

151 **Spot and stock welds.** The spot weld is the point of firm contact between the firer's cheek and thumb on the small of the stock (fig 66). It is obtained by lowering the cheek to the thumb, which is curled over the small of the stock, and rolling up a pad of flesh against the cheekbone to act as a buffer. The firm contact between the head, hand, and rifle enables the head and weapon to recoil as one unit, thereby facilitating rapid recovery between rounds. The spot weld also enables the eye to be positioned the same distance behind the rear sight aperture each time the rifle is aimed and fired. This causes the diameter of the rear sight aperture to appear the same each time a sight picture is obtained, thus further assisting in maintaining correct sight alignment. If the soldier is unable to obtain a spot weld he should use a stock weld (fig 67) by placing his cheek directly against the stock. The stock weld, if properly used, will achieve the same results as the spot weld.

161 **Breathing.** If the firer continues normal

breathing while aiming and firing the rifle, the movement of his chest will cause a corresponding movement of the rifle. To avoid this, the soldier must learn to hold his breath for the few seconds required to aim and fire the rifle. Initially, the firer takes a normal breath, releases part of it, and holds the remainder in his lungs. He should not hold his breath for more than approximately 10 seconds, otherwise, his vision may begin to blur, and lung strain may cause muscular tension.

171 **Relaxation.** The soldier must be able to relax properly in each firing position. Under muscular strain or tension causes trembling of parts of the body, which in turn causes a corresponding movement of the rifle. If he finds that a particular position causes excessive strain, he should adjust that position slightly until he is able to relax, providing he does not violate any of the other steady hold factors. An indication of a properly relaxed firing position is the soldier's ability to relax and still maintain his sight picture.



Figure 66 Spot weld



Figure 67. Stock hold.

181 *Trigger control* Trigger control is the independent action of the forefinger on the trigger pressing it straight to the rear with a uniformly increasing pressure until the weapon fires. The trigger finger should contact the trigger at some point between the tip and second joint of the finger (fig 65). The finger must not touch the side of the stock as this will cause pressure to be applied at a slight angle rather than straight to the rear. Such a side pressure on the rifle, no matter how slight, will tend to pull the sights off the aiming point. Correctly applied pressure on the trigger causes no movement of the rifle barrel. It also prevents the rifleman from knowing exactly when the rifle will fire, thus helping him to avoid flinching. Trigger control is the most important of the steady hold factors, and without its proper application the other marksmanship skills are practically useless. Therefore, instructors should continuously em-

phasize this fundamental point throughout rifle marksmanship training.

39. Firing Positions

a. The six standard firing positions taught in the rifle marksmanship program are the prone, prone supported, kneeling, kneeling supported, standing, and fashole. On the battlefield, a rifleman must assume the steadiest possible position which can provide observation of the target area and some cover and concealment. Considering the many variables of terrain, vegetation, and tactical situations, there are innumerable possible positions that might be used. However, in most instances they will be variations of those listed above.

b. Some soldiers will have more difficulty in assuming a particular position than will others. So long as the firer applies the fundamentals of maximum support for his rifle, relaxation, and

trigger control, he should be permitted to adjust the position to fit his own body conformation.

c. During initial training in fundamentals, positions are taught in a step-by-step process. The soldier is guided through a series of precise movements until he is in the correct position. This is to insure that he correctly applies all of the steady hold factors. Through practice, the soldier will gradually become accustomed to the feel of the positions and eventually he will know instinctively whether or not his position is correct. This is particularly important in combat since the soldier must be able to assume positions rapidly. There are any number of intermediate positions a combat rifleman might use before assuming his final firing position. He must know instinctively whether or not his position is correct rather than follow a set sequence of movements to insure its correctness.

d. Throughout position training, the soldier should be continuously checked to insure he is employing the proper application of the eight steady hold factors, particularly trigger control.

e. The methods of assuming the positions and the conditions governing their use are as follows:

(1) *Prone position.* The prone positions (fig 68 and 69) are relatively steady positions, which are easy to assume. These positions present a low silhouette and are easily adapted to the use of cover

and support. However, their effectiveness as battlefield firing positions is frequently limited since vegetation and irregularities of terrain will often limit the soldier's field of view.

(a) *Assuming the prone position.* To assume the prone position the firer stands facing his target, turns 30 degrees to his right (right handed firer), spreads his feet a comfortable distance apart, and drops to his knees. With his right hand at the heel of the stock, he places the rifle butt well out to his front on an imaginary line drawn between the target and his right knee. Using the rifle butt as a pivot, the firer rolls down on his left side, placing his left elbow as nearly under the rifle as possible. He positions the rifle butt into the pocket formed in his right shoulder, grasps the small of the stock with his right hand, and lowers his right elbow to the ground. His right elbow should be placed well out from his body and slightly forward so his shoulders are approximately level. The firer exerts a firm rearward pressure with his right hand. To complete the position, the firer obtains a spot weld and relaxes. His spine is straight, and his legs are spread a comfortable distance apart. Normally, the angle made by the firer's body and the axis of his rifle is approximately 30 degrees. This places enough of the firer's weight behind the rifle to absorb recoil without unduly disturbing his position.



Figure 68. Prone position



Supported
Figure 69. Prone position



2 Alternate
Figure 69—Continued

(b) Assuming the prone supported position. To assume the prone supported position (1, fig 69), the firer first assumes the prone position. He then adjusts the position to the available support, placing his left hand and forearm against the support. Whether the left elbow is directly under the rifle is of less importance in this position because now the support, rather than the arm, sustains the weight of the rifle. No part of the rifle should be touching the support as this reduces the firer's control of his rifle and hinders rapid recovery between shots.

(c) Alternate prone position. The alternate prone position is an alternate to both of the above positions allowing the firer to cock his right leg (2, fig 69) to assume a comfortable position while maintaining the same relationship between his body and the axis of the rifle. This position relaxes the stomach muscles and allows a heavier firer to breathe easier. In addition it shifts some of the firer's weight more directly behind the weapon thus absorbing the recoil better.

(2) *Kneeling positions.* These positions are suitable for use on level ground that slopes gently upward. They can be adjusted in height and are readily adaptable to such supports as rafters, corners of buildings, and vehicles.

(a) *Kneeling unsupported position.* To assume the kneeling unsupported position (1, fig 70), the firer faces his target and executes a right face. He places his left foot to his left front pointing toward the target. He kneels on his right knee, sitting on his right heel as he does so. He places his left upper arm on the flat portion of his left knee. With his right hand, he places the rifle butt into the pocket formed in the right shoulder. His right elbow should be horizontal, or slightly above the horizontal, to aid in forming a pocket in the right shoulder. To complete the position, he shifts his weight forward and obtains a spot weld. In 2, figure 70, two additional methods of positioning the right foot are shown when assuming the kneeling position.



1 Unsupported

Figure 70. Kneeling positions

(b) *Alternate kneeling position.* The alternate kneeling position is an alternate to the kneeling positions above allowing the soldier to drop his right elbow down to a position comfortable to the firer while still maintaining the proper placement of the butt in the shoulder to prevent the butt from slipping on the shoulder during firing (3, fig 70). This position is suggested for individual firers who have difficulty maintaining the right elbow horizontal to the ground without experiencing muscle strain and excessive movement of the rifle.

(c) *Kneeling supported position.* To assume the kneeling supported position (fig 71), the firer first assumes the kneeling position. He then shifts his weight forward, allowing his left shoulder, left arm, and left leg to come into contact with the support. The rifle should not touch or rest on the support, since the friction of the rifle against the support would slow recovery between shots and

limit the firer's ability to rapidly shift his point of aim.

(3) *Standing position.* The standing position (1, fig 72) is used in the assault, to engage surprise targets, and/or when no other position can be used.

(a) *Assuming the standing position.* To assume the standing position, the firer faces his target, executes a right face, and spreads his feet a comfortable distance apart. With his right hand at the small of the stock, he places the rifle butt high against his shoulder so that the sights are level with his eyes. He holds his right elbow high to form a pocket in his right shoulder. This also permits him to exert a strong rearward pressure with his right arm and hand. He places his left hand under the rifle in a position to best assist in supporting and steadying the rifle. To complete the position, the firer shifts his feet until he is aiming naturally at the

target and distributes his weight evenly on both hips.

(b) *Alternate standing position.* The alternate standing position (2, fig 72) is suggested for the individual firer who has difficulty maintaining the position above without experiencing muscle strain and excessive "wobble." To assume the alternate standing position, the firer faces the target, executes a right face, and places his feet a "comfortable" distance apart. The right hand and arm are placed the same as in the position above except that the right elbow may be dropped below the horizontal to a comfortable position. The left elbow is held tight against the firer's left side and the left hand grasps the bottom of the magazine (balance of the weep) palm up, with the base of the magazine resting in the palm of the hand in the "V" formed by the thumb and four fingers. The weight of the rifle should be supported by the firer's left forearm such that the elbow is resting on the firer's left side and the bone of the forearm is supporting the rifle weight rather than the muscles

of the left arm. The firer must arch his back slightly and obtain a good stock weld. To complete the position, the firer shifts his feet until he is aiming naturally at the target and distributes his weight evenly on both feet.

(4) *Foxhole position.* The foxhole position (fig 73) is used whenever such prepared positions are available. The soldier enters the foxhole, adds or removes dirt, sandbags, or other supports to best fit his height, and then assumes a comfortable firing position. He assumes this firing position by placing his feet as in the standing position and then leans forward until his chest is against the right forward corner of the foxhole. He extends his left arm and elbow over the forward side of the foxhole, allowing the parapet or sandbags to support the left forearm. The firer places the rifle butt into the pocket formed in the right shoulder and grasps the small of the stock with his right hand. He places the right elbow outside of the foxhole, blocking it against solid support. As in the other supported positions, the rifle must not rest on or touch the support.



2 Kneeling position, variations of right foot position
Figure 70—Continued



3 Alternate
Figure 79—Continued



Figure 71 Kneeling supported position



1 Primary
Figure 72 Standing position



2 Alternate
Figure 72—A, continued



Figure 73. Foxhole position.

40. Wobble Area

"Wobble" is the movement of the rifle that occurs during aiming. "Wobble area" is the extent of this movement in all directions. From the firer's viewpoint, the wobble area is indicated by the movement of the front sight post on and around the aiming point. This movement is a natural occurrence and can never be completely eliminated. The size of the wobble area depends upon the stability of the firing position.

a. *Firing Positions.* The more stable a firer's position, the smaller his wobble area will be. Therefore, if a firer has a choice of positions, he should select the most stable position that affords observation of the target area.

b. *Trigger Control.* Wobble is a relative matter; e.g. the prone position affords more stability than standing. Since the body, and thus the weapon, will tend to move back and forth and/or up and down, the inexperienced firer must be taught to apply pressure to the trigger during his wobble and not attempt to jerk the trigger when the sight picture "looks perfect." The application of this principle of pressing-through during the wobble will greatly reduce the tendency of the shooter to jerk or snap the shot which may result in a miss. Essentially, the firer must learn to control the pressure on the trigger so that the rifle will fire during the few seconds it is wobbling the least. As soon as the firer has obtained a correct sight picture, he applies

pressure to the trigger, even after the rifle fires. This procedure helps to prevent extensive wobbling at the instant the rifle is fired.

41. Fullthrough

Fullthrough is the continued application of the fundamentals after each round has been fired. That is, the firer maintains his position and sight alignment, holds his breath, and continues to press the trigger to the rear, even though the rifle has fired.

42. Calling the Shot

a. When a soldier "calls his shot" he is indicating the place on the target at which he thinks his rifle was aimed the instant it fired. In case of 25 meter range targets, a shot is "called" by indicating the relationship between where the rifle was pointing at the instant of firing, and the aiming point on the target. If his sights were aimed anywhere on the aiming point, the firer would call "Hit." Over or under the aiming point, the call would be either "High" or "Low" and to the sides, "Right" or "Left." These calls can also be combined, such as "High-right" or "Low-left." As the firer becomes more experienced he can become even more precise in his calls. For example, "Hit, high-right" would mean the firer hit the upper right portion of the black rectangular square. "Low, slightly left" would mean the firer was well beneath the aiming point but just barely off its left edge.

During 25-meter firing, the soldier must immediately record his call of the shot on his firing data card (fig 76).

b. Initially, soldiers may have difficulty in calling their shots. The primary reason for this is that many soldiers will not properly follow through and thus have no idea of their sight picture at the instant of firing. Such firers must receive close supervision if they are to correct this fault. The ability to call his shot will greatly assist the firer in zeroing his weapon.

43. Shot Group Analysis

a. A perfect shot group is one in which all rounds hit the target at exactly the same point. However, factors such as wind, the ability of the firer, and the slight manufacturing differences between rounds of ammunition make such a shot group virtually impossible. Shot groups are analyzed by studying the arrangement of the bullet holes on the target. The distance between these holes and the overall pattern made by the shot group are considered in determining the proficiency of the firer. As a general rule, the smaller the pattern, the better the shot group (fig. 74).

b. Most unsatisfactory shot groups are elongated, either vertically or horizontally, and are the direct result of incorrect sight pictures. That is, at the instant of firing, the soldier has an error in sight alignment, in the placement of the aiming point, or a combination of the two. However, the fact that an obviously incorrect sight picture occurred at the instant of firing does not necessarily isolate it as the only mistake. For example, incorrect application of pressure on the trigger will almost always pull the sights out of alignment

and/or off the aiming point. Improper breathing or undue muscular strain can also cause aiming errors, although these are less common mistakes than improper trigger control. Instructors must keep in mind that any of several improperly applied fundamentals can disarrange the sight picture and cause unsatisfactory shot groups. Consequently, they should carefully observe a firer's application of all fundamentals to insure that the actual mistake is identified.

c. Assuming that all fundamentals except aiming have been eliminated as the cause of the firer's unsatisfactory shot groups, the coach or instructor can then use the size and configuration of the shot group patterns to determine the specific type of aiming error. The relationship of these patterns to the type of aiming errors is as follows:

(1) Long, vertical shot groups are the result of vertical sight alignment. That is, the firer has positioned the front sight blade too high or too low in the rear sight aperture.

(2) Long, horizontal shot groups are the result of improper horizontal sight alignment. That is, the firer has positioned the front sight blade too far to the right or left in the rear sight aperture.

(3) A small or "tight" shot group indicates proper application of the sight steady hold factors, and correct sight picture.

d. During fundamentals training, each soldier should be given a rifle shot group analysis card (fig 74) to assist him in determining and correcting his own mistakes. These cards depict several different types of unsatisfactory shot groups, the probable errors that caused them, and the necessary corrective action.

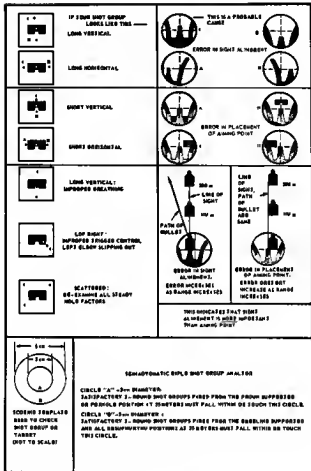

OTA 21-1 - RIFLE SHOT GROUP ANALYSIS CARD;
 SEMI-AUTOMATIC FIRE WITH M16/M16B RIFLES (P420-7)

Figure 74. Rifle shot group analysis card (OTA 21-1-4).

CHAPTER 4

PREPARATORY MARKSMANSHIP TRAINING AND 25-METER FIRING

Section 1. PREPARATORY MARKSMANSHIP AND CONDUCT OF TRAINING

44. General

All preparatory marksmanship training is conducted on the 25-meter range (fig 751). The soldier is taught, through a series of conferences, lectures, demonstrations, and practical exercises, the correct application of the fundamentals of rifle marksmanship. Throughout the conduct of live firing, the ability of the soldier to apply these fundamentals is demonstrated by the size of his shot groups on the target. Those personnel who have unusual difficulties in mastering the ability to fire tight, three-round shot groups are sent to an area of remedial instruction where they are given individual attention by the best qualified rifle marksmanship instructors available. In the last phase of 25-meter firing, the soldier obtains the 250 meter battlesight zero for his rifle.

45. Conduct of Training

a. Organization.

(1) Based on a 200-man unit, the range should have 110 firing points. The unit is divided into two

orders, and the soldiers in the first order are paired with soldiers in the second order. Each pair of soldiers is then assigned a firing point, beginning with point number 1 and extending through point number 100. One order is designated as firers. The extra 10 firing points are used to conduct remedial instruction.

(2) On 25-meter ranges a foxhole, stump, and sandbags are provided at each firing point so instruction firing from the supported positions can be conducted.

(3) A control tower should be centrally located to the rear of the firing line. It should be sufficiently elevated to permit unrestricted observation of the range, both to the rear of the firing line and a reasonable distance beyond the line of targets. All firing commands are issued from the control tower and must be obeyed immediately. The single exception to this is in the event an unsafe act occurs. In this case, the first individual to see such an act should command CEASE FIRE.

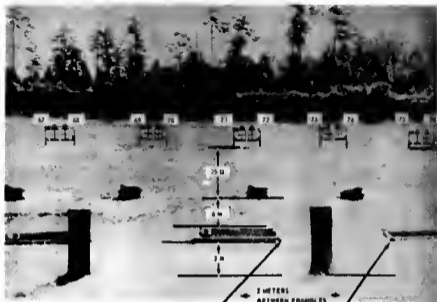

Figure 75. The 25-meter range.

141 To provide both safe and efficient range operation and effective instruction, the following personnel are required:

- (a) Officer in charge.
- (b) Safety officer.
- (c) Noncommissioned officer in charge.
- (d) Ammunition detail.
- (e) Ordnance small arms repairman.
- (f) One assistant instructor per every five to ten points.
- (g) Medical personnel.

151 Prior to beginning each live fire exercise, all personnel must be briefed on the range safety regulations.

161 As a soldier completes firing a shot group, his rifle is checked and cleared by an assistant instructor. When all rifles have been cleared, the control tower operator announces that the firing line is clear, and firers may move down range and stand by their targets until critiqued by an assistant instructor.

b. Exercises.

(1) *Firing data card (DA Form 83).*

(a) The firing data card (fig 76) is used in each firing exercise throughout marksmanship fundamentals training. This card provides a record of the "calls," "hits," position fired from, sight used for each, and the battlesight zero.

(b) Properly used, the firing data card is a valuable aid to the firer and the instructor, since it provides an excellent means of analyzing each soldier's progress and marksmanship proficiency.

(c) The "call" is plotted on the call target of the firing data card immediately after each shot is fired. "Calls" are plotted in numerical order (i.e., 1, 2, 3) until all rounds of the shot group exercise have been fired. After the firing line has been cleared, firers will go forward, check their targets, and record the exact location of each hit as a penciled dot on the hit target.

FIRING RECORD

For use of 1 to form, see FM 23-8; the proper agency is TRADOC.

1 CALL TARGET	NY TARGET	7 CALL TARGET	NY TARGET	13 CALL TARGET	NY TARGET
POSITION DOWN	EL 12 W 0	POSITION DOWN	EL 11 W 5 L	POSITION KNEELING SUP	EL 12 W 2 L
2 CALL TARGET	NY TARGET	8 CALL TARGET	NY TARGET	14 CALL TARGET	NY TARGET
POSITION DOWN	EL 30 W 5 L	POSITION DOWN	EL 13 W 5 L	POSITION KNEELING SUP	EL 13 W 3 L
3 CALL TARGET	NY TARGET	9 CALL TARGET	NY TARGET	15 CALL TARGET	NY TARGET
POSITION DOWN	EL 16 W 4 L	POSITION DOWN	EL 19 W 4 L	POSITION KNEELING SUP	EL 13 W 3 L
4 CALL TARGET	NY TARGET	10 CALL TARGET	NY TARGET	16 CALL TARGET	NY TARGET
POSITION DOWN	EL 18 W 4 L	POSITION KNEELING	EL 18 W 5 L	POSITION STANDING	EL 13 W 3 L
5 CALL TARGET	NY TARGET	11 CALL TARGET	NY TARGET	17 CALL TARGET	NY TARGET
POSITION DOWN	EL 17 W 2 L	POSITION KNEELING	EL 18 W 3 L	POSITION STANDING	EL 19 W 5 L
6 CALL TARGET	NY TARGET	12 CALL TARGET	NY TARGET	18 CALL TARGET	NY TARGET
POSITION DOWN	EL 31 W 5 L	POSITION KNEELING	EL 13 W 3 L	POSITION STANDING	EL 14 W 3 L
7 CALL TARGET	NY TARGET	13 CALL TARGET	NY TARGET	19 CALL TARGET	NY TARGET

DA FORM 83, 1 Nov 73

EDITION OF 1 JUN 68 IS OBSOLETE.

1 Front

Figure 76. Firing data card (DA Form 83), M14 rifle.

10 CALL TARGET HIT TARGET X 1 3	HIT TARGET	25 CALL TARGET HIT TARGET X 1 3	HIT TARGET	31 CALL TARGET HIT TARGET X 1 3	HIT TARGET
POSITION FOUNDS 21 CALL TARGET HIT TARGET X 1 3	EL 15 W 2L HIT TARGET	POSITION PRONE SUP 26 CALL TARGET HIT TARGET X 1 3	EL 15 W 2L HIT TARGET	POSITION PRONE SUP 32 CALL TARGET HIT TARGET X 1 3	EL 15 W 2L HIT TARGET
POSITION FOUNDS 21 CALL TARGET HIT TARGET X 1 3	EL 15 W 2L HIT TARGET	POSITION PRONE SUP 27 CALL TARGET HIT TARGET X 1 2	EL 15 W 2L HIT TARGET	POSITION PRONE SUP 33 CALL TARGET HIT TARGET X 1 3	EL 15 W 2L HIT TARGET
POSITION FOUNDS 22 CALL TARGET HIT TARGET X 1 2	EL 15 W 2L HIT TARGET	POSITION PRONE SUP 28 CALL TARGET HIT TARGET X 1 2	EL 15 W 2L HIT TARGET	POSITION KNEELING BATTLE SIGHT ZEROING 1ST GROUP 2ND GROUP	EL 15 W 2L HIT TARGET
POSITION PRONE SUP 23 CALL TARGET HIT TARGET X 1 3	EL 15 W 2L HIT TARGET	POSITION STANDING 29 CALL TARGET HIT TARGET X 1 2	EL 15 W 2L HIT TARGET	3RD GROUP 4TH GROUP	EL 15 W 2L HIT TARGET
POSITION PRONE SUP 24 CALL TARGET HIT TARGET X 1 2	EL 15 W 2L HIT TARGET	POSITION STANDING 30 CALL TARGET HIT TARGET X 1 3	EL 15 W 2L HIT TARGET	NAME <u>GOLDSMITH GEORGE</u> UNIT <u>CO. I</u> ISM <u>175-31-3648</u> RIFLE NO. <u>31547</u> 250 METER BATTLE SIGHT ZERO	EL 15 W 2L HIT TARGET
POSITION PRONE SUP	EL 15 W 2L	POSITION STANDING	EL 15 W 2L	EL 15 W 2L	EL 15 W 2L

2 Back
Figure 76—Continued.

(2) *Progress booklet.* Each soldier should be required to maintain a progress booklet throughout his marksmanship training. The booklet should contain his 25-meter targets, firing data card, shot group analysis card, field firing scorecards, and target detection answer sheets. With this in-

formation, instructors can review a soldier's performance and accurately identify those areas that are causing difficulty.

c. *Remedial Instruction.*

(1) *Purpose.* During some phases of marksmanship fundamental training, a few soldiers

will have more difficulty understanding and applying the various techniques than others. To provide the extra instruction required by the less skillful firers without delaying the progress of the entire unit, a concurrent, remedial training area should be used. If a separate range is not available for this concurrent training, a number of firing points should be set aside on the 25 meter range for this purpose.

(2) *Conduct.*

(a) In practically every instance, the size and configuration of shot groups will identify those firers having difficulty. Once they have been identified, assistant instructors should be assigned to provide individual remedial instruction. Only the best qualified instructors should be designated to conduct remedial instruction. They must be well grounded in marksmanship fundamentals, alert to common shooting errors, and have a thorough understanding of how to quickly correct these errors. In some cases, the instructor can determine the cause of the firer's deficiencies simply by discussing the problem with him and examining his shot groups and other data contained in the progress booklet. However, in the majority of cases, the instructor must closely observe the soldier fire several rounds before the cause of his errors can be determined.

(b) Time is a definite factor in remedial instruction. While a firer is receiving remedial instruction, he will, if necessary, miss the regularly scheduled training of his unit. In view of this, the instructor should provide intensified training on those subjects the firer has missed, before he rejoins his unit.

(c) If the instructor determines improper trigger control to be the source of the firer's difficulty, he may be able to correct this simply by telling the firer his specific error. A firer who flinches can sometimes overcome this tendency by using surplugs. However, if these procedures fail to produce the desired results, the M2 aiming device

can be used to improve trigger control techniques. This device is fitted over the rear sight so the instructor can observe the same sight picture as does the firer (fig 77). The instructor sees a reflected image of the sight picture, the effect of the firer's trigger control on sight alignment, and whether the firer is correctly calling his shot; e. g. if the firer correctly calls the shot "right," it will appear to be left in the device. To gain the most benefit from the device, the instructor must look directly into the device and continuously adjust his position as necessary. The instructor must watch closely for any sudden changes in sight picture the moment before firing. Any such sudden change will indicate that the firer is either flinching or bucking. This device may be used during any phase of preparatory marksmanship and is particularly valuable in conducting remedial instruction.

(d) So far as possible, the ball and dummy exercise should be used extensively throughout remedial instruction. Initially, some types of exercises, such as positions and aiming, are better conducted without live ammunition. However, regardless of the training technique used, each soldier should be required to fire several ball and dummy exercises before being returned to the regular class. The instructor must closely supervise this firing to insure that the soldier has, in fact, overcome his difficulties. In the ball and dummy exercise, the instructor loads a dummy round or a live round into the rifle. The firer must not watch the instructor load his rifle, since the value of the exercise is based on the firer not knowing if a live round is in the chamber. The firer is told to aim, apply the steady hold factors correctly and fire. The instructor observes the firer's eyes and face for evidence of flinching, the trigger finger for improper trigger control, and the back and chest for improper breathing techniques. When a soldier attempts to fire a dummy round, any of these errors will become apparent to an observant instructor.



Figure 17. M2 aiming device

(c) There are two exercises which may be used to effectively teach aiming. The first exercise is conducted using an aiming bar, and the second a rifle rest, target box, and disk.

(3) *First aiming exercise.* The aiming bar (fig 78) is designed to teach sight alignment and placement of the aiming point. Continuous visual checks are made by the assistant instructor to insure that the firer applies the correct principles of sight alignment and placement of the aiming point. This exercise is conducted as follows:

(a) The firer moves the rear sight on the aiming bar until he considers the sight alignment to be correct. The assistant checks the result. If the alignment is incorrect, the assistant determines the error and makes the necessary corrections. If the alignment is correct, the assistant moves the sight to cause a misalignment and returns the aiming bar to

the firer. The firer must then correct the misalignment. Assistant instructors should continuously check the performance of assistants and firers. This exercise is continued until the principles of correct sight alignment are clearly understood.

(b) In the second step of the exercise a small metal target is placed on the aiming bar, and the soldier is required to complete the sight picture placing the aiming point in correct relation to the sight alignment. As in the first part of the exercise, the firer's completed work is checked by the assistant, and both are continuously checked by the assistant instructors. The assistant again corrects the errors of the firer. If the sight picture is correct, the assistant moves the target end sight to cause improper sight alignment and placement of the aiming point. The firer must then repeat the exercise.

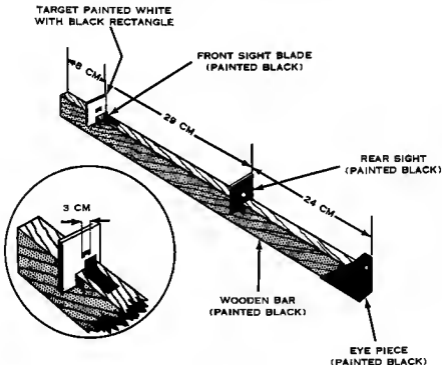

Figure 78. Aiming bar.

14) *Second aiming exercise.* To conduct this exercise, a rifle, a rifle rest, a target box, and a target disk are required for each assistant and firer team (fig. 79). Blank paper attached to the target box is used to record aiming points. A miniature 25-meter target is painted on the disk. A small hole is made in the center of the disk so the assistant can insert the point of a pencil and mark the firer's point of aim. The exercise is conducted as follows:

(a) The rear sight is set at 12 clicks of elevation and zero windage, and the rifle is then braced in the rest. The firer assumes a position beside the rifle so that his eye is as close as possible to the rear sight without disturbing the lay of the weapon. He places both elbows on the ground and rests his chin in the palm of his left hand. The

assistant sits on the target box located 15 meters from the firer. This distance produces approximately the same front sight blade and aiming point relationship as exists during 25-meter firing. The assistant holds the target disk against the paper on the target box. The firer signals the assistant with his right hand to move the disk until the correct sight picture is obtained. He then clenches his fist and gives the command, MARK. The assistant records the sight picture by marking the paper with his pencil through the hole in the disk. This procedure is repeated until three sight pictures, called a shot group, have been recorded. The firer must keep his eye in the same position with relation to the rear sight aperture each time he obtains a sight picture.



Figure 79 Rifle rest, target box, and disk exercise

CAUTION To obtain valid results, there must be no movement of the rifle, the rifle rest, or the target box until all three sight pictures have been recorded. If any of these items are

accidentally moved before three sight pictures have been recorded, the firer must repeat the entire exercise.

(b) An assistant instructor critiques the shot

group, using the shot group analysis card (fig 74) as a guide. A satisfactory shot group can be covered by the unsharpened end of a pencil.

d. Conduct of Firing.

11) *Clean and blackened sights.* A firer can experience difficulty in obtaining a proper sight picture because of shiny or dirty sights. A shiny front or rear sight will glare and partially blind the firer. Dirt can change the distinctive sight outline and cause errors in aimment. Then, it is important in training and in combat to continually inspect rifle sights, cleaning and blackening them as necessary. During marksmanship training, materials for this purpose should be available on the range. In combat, the soldier can use a cleaning patch or handkerchief to clean the sights, and he can blacken them with an ordinary match flame.

12) *Fire commands.* In order to simplify firing

procedures, fire commands should be brief and standardized as much as possible from one exercise to the next. A sample fire command follows: **FIRERS ASSUME THE PRONE POSITION. ASSISTANT, SECURE THREE ROUNDS OF AMMUNITION AND LOAD THESE INTO THE MAGAZINE. GIVE THIS MAGAZINE TO THE FIRER. THE FIRING LINE IS NO LONGER CLEAR. FIRER: LOCK; WITH ONE THREE-ROUND MAGAZINE, LOAD. YOU WILL FIRE AT THE (NUMBER OR LOCATION) TARGET. COMMENCE FIRING WHEN READY. CEASE FIRING. CLEAR ALL WEAPONS. CLEAR ON THE RIGHT? CLEAR ON THE LEFT? THE FIRING LINE IS CLEAR. FIRERS MOVE DOWN RANGE AND CHECK YOUR TARGETS.**

Section II. M14 AND M14A1 SIGHTS

46. General

Following fundamentals training, the soldier must zero his weapon. In order to accomplish this, the soldier must first learn the operation of the rear sight, the use of the elevation and windage knobs, and how to compute sight changes.

47. Sights

a. The rear sight (fig. 501) of the M14 and M14A1 rifle has an elevation knob and a windage knob which are used to move the rear sight aperture up or down and right or left respectively. Changing the position of the rear sight aperture causes a corresponding change in the location of the strike of the bullet. The elevation knob affects the vertical location of the strike of the bullet, while the windage knob affects the horizontal location. Both knobs make an audible click when they are turned. Each click changes the strike of the bullet a specific distance, depending on the range to the target. The elevation knob is adjustable from 0 to 72 clicks.

The rear sight aperture can be adjusted from 0 to 16 clicks to the right or left of the center index line by rotating the windage knob.

b. During initial training in marksmanship fundamentals, the soldier should conduct all firing exercises with the rear sight of his service rifle set at 12 clicks of elevation and zero windage. This setting should not be changed until the soldier is able to fire satisfactory shot groups. Any sight changes made before the soldier obtains his best-sight zero should be supervised. The reason for this is two-fold; first, untrained firers will tend to focus their attention on manipulating the sight rather than learning to properly apply marksmanship fundamentals. Second, during fundamentals training, the precise location of shot groups on the target is unimportant since it is the size of the shot groups and not the location that governs the proficiency of the firer.

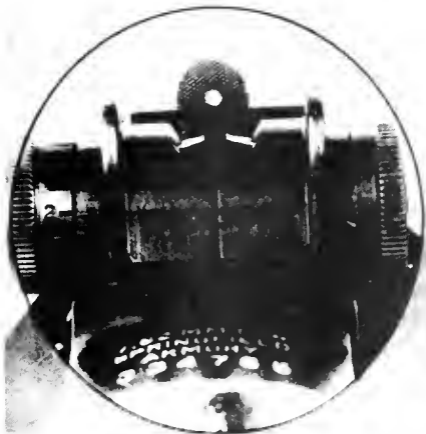

Figure 50. Near night M14 rifle.

48. Elevation and Windage Rule

The elevation and windage rule states that one click of elevation or windage will move the strike of a bullet a specific distance at a specific range. At a range of 25 meters, one click of either elevation or windage on the sight of the M14 M14A1 rifle will move the strike of the bullet approximately 7 centimeters. To compute the distance that one click of elevation or windage will move the strike of a bullet at a given range, divide the range (expressed in meters) by 25 meters and multiply by 7 cm.

$$D = \frac{R \times 7}{25M} \quad \begin{array}{l} D = \text{Distance in centimeters} \\ R = \text{Range in meters} \end{array}$$

EXAMPLE: To compute the distance that one click of elevation or windage will move the strike of the bullet at a range of 250 meters, simply divide 250m by 25m and multiply by 7 cm.

$$D = \frac{250m}{25m} \times 7 = 10 \times 7 = 7 \text{ cm}$$

Therefore, $D = 7 \text{ cm}$

49. Sight Changes

a. To make sight changes, the firer first locates the center of his shot group and then determines the distance between it and the desired location. The distance in elevation is determined vertically while distance in windage is determined horizontally. These distances are converted to clicks by using the elevation and windage rule. As a general rule, bold adjustments will prove more advantageous to the firer. For example, if the firer cannot decide whether to move two or three clicks, he should normally make the adjustment requiring the greater number of clicks.

b. To raise the strike of the bullet, the firer must increase the number of clicks of elevation. Conversely, he decreases the elevation to lower the strike of the bullet on the target. Right windage moves the strike of the bullet to the right, and left windage moves it to the left.

50. Progress Check

a. *Purpose.* Prior to obtaining his battlesight zero, each soldier should fire an exercise to measure his fundamental shooting skill. This exercise is called a progress check. The results of the progress check will enable instructors to identify specific deficiencies and to take advantage of scheduling

procedures in the subsequent battlesight zero period.

b. *Conduct of Exercise.* To conduct a progress check, each soldier must fire three, three-round shot groups from the prone, kneeling, kneeling supported, and foxhole supported position. Assistant instructors check the results after each shot group is fired, using a shot group template. This template is made of transparent plastic with two circles imprinted on it. One circle is 3 centimeters in diameter and the other 5 centimeters. In checking shot groups fired from the two supported positions, kneeling supported and foxhole supported, the three rounds must lie on or within the 3-centimeter circle to be considered satisfactory. The 5-centimeter circle is used in checking shot groups fired from the unsupported positions. Again, the three rounds must lie on or within the 5-centimeter circle to be considered satisfactory. Soldiers should be given an opportunity to retire from those positions found to be unsatisfactory if there is sufficient time and ammunition available. New recruits must receive a formal progress check as an integral part of their marksmanship training. The shot group template should be continually used to check and critique shot groups during all 25-meter firing.

Section III. BATTLESIGHT ZERO

51. Principles of Zeroing

a. In order to understand the principles of zeroing, the soldier should have a basic knowledge of ballistics, specifically, the relationship between the path of the bullet in flight and the line of sight. In flight, a bullet does not follow a straight line but travels in a curve or arc. This curved flight path of the bullet is called a trajectory. The maximum height of a bullet's trajectory, in relation to the line of sight, depends on the range to the target. The greater the distance a bullet travels before impact, the higher it must travel in its trajectory. On the other hand, the line of sight is a straight line distance through the rear sight aperture, across the front sight blade to the point of aim.

b. After the bullet leaves the rifle, it is initially moving in an upward path. The bullet will intersect and begin to travel above the line of sight a short distance from the muzzle. As the bullet travels farther, it begins to drop and will eventually again intersect the line of sight. The range at which this intersection occurs is the zero for that sight setting.

c. Current doctrine of the United States Army prescribes a battle-sight zero at 250 meters. That is, the rear sight of a rifle should be so adjusted that the trajectory of the bullet and the line of sight

intersect at a range of 250 meters. To phrase it another way, a soldier firing a rifle properly zeroed for a range of 250 meters should hit his point of aim at that range.

d. One method of determining the 250-meter battlesight zero would be to fire at a 250-meter aiming point, making the necessary adjustments to place the center of the shot group on the point of aim. However, such a method would waste training time while firers moved between the firing line and the targets to check the location of shot groups.

a. A more suitable method of determining the 250-meter battlesight zero can be accomplished at a range of 25 meters (fig. 81). This method is based on the principle that bullets of the same type and caliber fired at the same range have the same trajectory. That is, if several bullets were fired from the same rifle and all hit the same point of aim at 250 meters, the trajectories of all these bullets would be the same. Therefore, when each of them reaches a distance of 25 meters from the muzzle of the rifle, it is the same height above the firer's line of sight. Thus, by placing an aiming point at a range of 25 meters, the firer has only to adjust his shot group the prescribed height above the point of aim to obtain a zero for 250 meters.

52. Battlesight Zero Target

The standard 25-meter target is used for the battlesight zero exercise (fig 82). In order to use the elevation and windage rule effectively, the firer must know the dimensions of the target. The vertical and horizontal lines printed on the target

form 1.4-centimeter squares. As indicated in paragraph 48, one click of elevation or windage will move the strike of the bullet .7 centimeter at a range of 25 meters. Thus, two clicks of elevation or windage will move the strike of the bullet one square on the 25-meter target.

PRINCIPLE OF BATTLESIGHT ZEROING

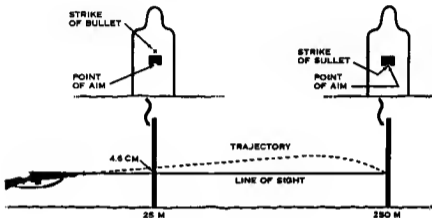
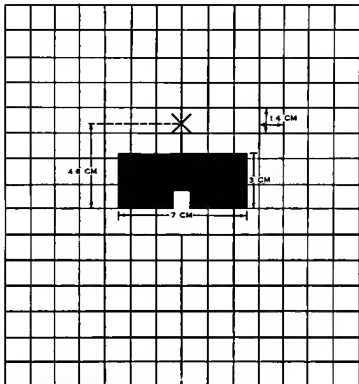

Figure 82. Principle of battlesight zero.



NOTE: TWO CLICKS OF ELEVATION OR WINDAGE WILL COVER THE STRIPE OF THE BULLET ONE SQUARE ON THE TARGET.

Figure 22. The 25-meter target (FSN 6920-906-0169).

53. Determining the Battlesight Zero

a. The 250-meter battlesight zero is determined by firing a series of three-round shot groups at the 25-meter target described in paragraph 52. The firer aims at the distinctive aiming point at the bottom center of the black rectangle and adjusts his rear sight until the center of his shot group is located 4.6 centimeters directly above the point of aim. This point is designated by an "X" printed on the target. With this sight setting, an aiming point at a range of 250 meters will coincide with the bullet's point of impact. The average soldier will need to fire three or four shot groups in order to accurately determine the battlesight zero of his weapon.

b. Once the zero has been established, there should be no further adjustment of the rear sight. In far field firing exercises, the soldier will learn to hit targets located at ranges other than 250 meters by adjusting his point of aim.

c. Either of the two most stable firing positions, the foxhole or prone supported, may be used for obtaining the battlesight zero. However, the position selected must be located on the prescribed 25-meter firing range.

54. Calibration of the Rear Sight

a. After the soldier has obtained the battlesight zero for his rifle, he must calibrate the rear sight. This procedure is necessary since, throughout the

marksmanship course, the soldier must continuously check the rear sight and, if necessary, reestablish the correct setting if the adjusting knobs have been moved.

b. Calibration procedure is as follows:

(1) Turn the elevation knob forward until the rear sight aperture is at its lowest possible setting. The firer should count the number of clicks as he lowers the rear sight aperture and should compare the number to that which is recorded on his firing data card.

(2) Loosen the screw in the center of the elevation knob until the knob can again be turned forward.

(3) Turn the elevation knob forward until the 250-meter index line (the long line between the

numbers 2 and 4 on the elevation knob) is opposite the index line on the receiver.

(4) From this point, turn the elevation knob forward the number of clicks of the 250 meter battlesight zero setting.

(5) Hold the elevation knob in position and tighten the center screw. Next, turn the elevation knob to the rear until it is at its highest possible setting and again tighten the center screw.

(6) To check the adjustment, set the 250-meter index line on the elevation opposite the index line on the receiver. Then turn it forward, counting the clicks. The number of clicks will be equal to the battlesight setting if the sight has been calibrated correctly.

FIELD FIRING

Section I. CONDUCT OF TRAINING

55. Purpose and Scope

Field firing provides the soldier with practical experience in firing at realistic targets located at ranges comparable to those of the battlefield. Field firing begins with simple exercises designed to familiarize the soldier with the range, the targets, and the scoring system. During the first field firing exercise the soldier will have sufficient time to check his position and sight picture and fire at the target. However, in subsequent exercises, speed becomes an increasingly important factor since a time limit is imposed on the firer. In later exercises there are added requirements such as rapid reloading, reducing stoppages, and engaging multiple targets. Initially, the soldier fires from the more stable positions and gradually progresses to the least stable positions. Toward the end of his field firing training, he is required to physically advance toward the targets, quickly move into position, and fire when the targets appear.

56. Center of Target Technique of Target Engagement

a. With a 250-meter battlesight zero, a firer can successfully engage targets out to 300 meters with the M14/M14A1 rifle by aiming at the center of his target. This is due to the relatively flat trajectory of the 7.62-mm round. Since the rifle has a maximum effective range of 460 meters without the bipod, and a maximum effective range of 700 meters with the bipod when employed in the semiautomatic role, it is necessary to have a method of sight adjustment to effectively engage targets beyond 300 meters.

b. This sight adjustment is accomplished as follows:

(1) Insure that the 250-meter battlesight zero has been calibrated on the rear sight (para 54).

(2) Determine the range to the target to the nearest 100 meters.

(3) Place the determined range on the rear sight by aiming the appropriate range line on the elevation knob with the index line on the receiver. For example, if it is determined that the range to the target is 600 meters, align the "6" (600 meter) line on the elevation knob with the index line on the receiver. This method should enable the firer to hit close enough to the target to obtain kills out to the

maximum effective range of the rifle by aiming at the center of the target.

c. *Effects of Wind.* Winds blowing across the firer's front will cause some lateral movement of the bullet while in flight. The effects of wind on a projectile depends on the velocity of the wind, the direction of the wind, and the range to the target. As the wind velocity and range to the target increases, the effect on the bullet increases. The firer compensates for wind effect by employing hold-off. Refer to paragraph 118a for a more detailed explanation of wind effect.

57. Rapid Reloading

During a 25-meter range firing, the soldier receives initial training and practical exercises in the techniques of rapid reloading. To continue his training in this skill, the soldier will fire several exercises during which he must rapidly reload. To conduct these exercises, the ammunition is issued in two magazines. As soon as the firer has expended all of the ammunition in the first magazine, he must rapidly reload and be ready to engage the next target when it appears. The soldier armed with the M14 rifle may run out of ammunition and not realize it until he attempts to fire. In such cases he should still attempt to reload and engage the target within the prescribed time limit. In any event, there is no time added in the exercise for the purpose of reloading.

58. Reduction of Stoppages

During the later field firing exercises, one dummy round should be placed among the live rounds in the firer's magazine. When this round fails to fire, the soldier must rapidly apply immediate action, resume his position, and fire at the target. Unless the soldier learns to perform this action rapidly and almost instinctively, the target will be gone before he can fire. In combat, a slight hesitation in performing immediate action might give an enemy soldier just time enough to fire a killing round. Since speed is important, the firer must not be given additional time during the exercise to perform the immediate action required.

59. Positions and Engaging Single Target

a. Field firing continues the soldier's training in firing from both supported and unsupported

positions. However, greater emphasis is placed on the combat application of these firing positions. Since the combat rifleman may be either moving or in a stationary position when he encounters the enemy, he must be proficient in rapidly assuming a firing position and engaging targets in either situation. In some field firing exercises, the firer engages targets from stationary positions, while in others he is required to walk forward and, when targets appear, rapidly assume a position and fire. Speed is emphasized by limiting target exposure time. As he progresses through field firing, each soldier should eventually be able to effectively engage targets at ranges out to 200 meters within 5 seconds and targets beyond 200 meters within 10 seconds.

b. The purpose of imposing different time limits for targets at different ranges is to emphasize the fleeting nature of combat targets and the definite correlation which exists between the range to the target and the time required to hit it. As a general rule, it requires more time to fire an effective round at longer ranges since the firer must take extra care in his application of fundamentals. From the combat rifleman's viewpoint, this relationship between range and time must also take into consideration the degree of personal danger posed by enemy targets. Normally, the closest enemy targets are the most dangerous, and the speed with which they are engaged becomes increasingly important as the range decreases. Considering all of these factors then, the combat rifleman must possess both speed and accuracy in firing on enemy targets. At shorter ranges (200 meters and less) speed must be emphasized and at longer ranges (over 200 meters) accuracy must be emphasized. For soldiers moving in the open, these factors have an added application in determining the best firing position from which to engage surprise enemy targets. In such situations, the standing position is obviously the quickest and easiest firing position to assume. However, it is also the least stable. Experience has shown that in the standing position the chances of hitting targets beyond 100 meters within 5 seconds are slight. The prone position, on the other hand, is the most stable of all the unsupported positions; however, it too has limited application on the battlefield. The reason is that once in the prone

position, the firer will usually discover that terrain and/or vegetation has masked the target. Thus, firers moving in the open, who detect targets beyond a range of 100 meters, should normally assume the kneeling position. Through practice, the firer can determine which of the positions provide the best combination of speed, accuracy, and observation for various target situations and his own capabilities.

60. Engaging Multiple Targets

If a combat rifleman observes three enemy soldiers, he fires at the one presenting the greatest danger to him, normally the nearest. When he fires, he can expect the other two to quickly seek cover. Consequently, the rifleman must be able to rapidly shift his point of aim and fire at a second and even a third enemy soldier before they have an opportunity to reach a protected position. The last exercises conducted during field firing training are designed to present such multiple target situations to the firer. As in the single target exposure exercises, the firer must engage the targets within prescribed time limits and from various firing positions.

61. Application of Marksmanship Fundamentals and Corrective Instruction

a. Although field firing exercises are primarily designed to develop skills which cannot be logically developed on 25-meter ranges, the fundamentals learned during this earlier training phase must continue to be emphasized. Instructors should check firers particularly for indications of improper trigger control. Many soldiers firing under pressure of a time limit will develop a tendency to jerk the trigger. This error must be corrected before it becomes a habit.

b. A second fundamental frequently slighted on the field firing range is that of position. Continued emphasis must be placed on the importance of correct body position. Since time is a factor in field firing exercises, it should be emphasized that it requires no longer to assume a correct position than it does an incorrect one, and that firing results are considerably better from a correct position. Firers committing major errors in fundamentals should be returned to the 25-meter range for corrective instruction.

Section II. RANGE OPERATION

62. Range Facilities

Whenever possible, field firing exercises should be conducted on standard field firing ranges constructed for this specific purpose. If such ranges are not available, field firing can be conducted on a

known distance range. However, both the known distance range and course of fire must be modified to accomplish this. Even with these modifications, the firing conducted on the known distance range is, at best, expedient training and cannot be con-

sidered comparable to the benefits gained from training on standard field firing ranges.

63. Operation of Standard Field Firing Range

The standard field firing range is constructed on open, flat terrain having a minimum depth of 300 meters (fig 831). The vegetation is removed so that targets will be clearly visible to the firer. The standard range consists of 35 lanes, and will accommodate a maximum of 105 soldiers in three 35-man firing orders. Foxholes and stumps are placed along the firing line in order to continue training in

firing from supported positions. Control points are also required to regulate the forward progress of fires during movement-type exercises. The stumps and foxholes are used as two of these control points. Numbered stakes are placed forward of the foxholes and other stakes are placed in rear of the stumps to provide additional control points. The starting points are located behind the rear numbered stakes and can be designated by stakes, a line placed on the ground, or a line of ready chairs.

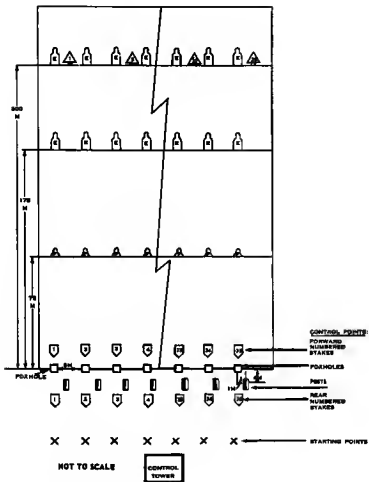

Figure 83. Standard rifle marksmanship field firing range.

a. *Targets.* There are three rows or banks of targets on the standard field firing range. One bank is located at a range of 75 meters, the second at 175 meters, and the third at 300 meters. The targets are silhouettes shaped in the general outline of a man. At 75 meters, the F-type silhouette target is used. This depicts the head and shoulders of an average size man. The E-type or full body silhouette, is used at ranges of 175 and 300 meters.

b. *Target Devices.* Each target is allixed to an automatic target device (fig 84) which is electrically operated and can be centrally or individually controlled. The most satisfactory control method is to connect all of the targets in one bank into one switch. This switch will then raise or lower the entire target bank at one time. Except for the initial field firing exercise, targets are exposed for a prescribed period of time and then lowered, since it requires 1 or 2 seconds for the mechanism to physically raise the targets, timing should begin when the targets are fully exposed rather than the moment the switch activates the mechanism. Time limits and sequence of target exposures are prescribed on the scorecard for the exercise being conducted.

c. *Scoring.* When a target is hit by a bullet, the vibration activates a mechanism in the device which causes the target to fall, simulating "kill." Each kill is scored as a hit for the firer. If the target does not fall, the firer receives a miss. During timed exercises, an audible signal such as a buzzer, whistle, or bell should be used to indicate the expiration of the time limit. Rounds fired after the signal has sounded are scored as misses.

d. *Range Organization.* The organization of firers and range personnel to conduct field firing is as follows:



Figure 84 Automatic target device (M31A1)
with E-type silhouette

(f) *Firers.* Normally, the training schedule requires half of a 200-man unit to receive training on the field firing range while the remainder of the unit either fires on the 25-meter range, receives instruction on target detection, or participates in other training deemed appropriate by the commander. Those on the field firing range are divided into three orders. Initially, the first order is designated as firers, the second as scorers, the third as the ammunition detail. Their duties are then rotated.

(2) *Range personnel.* For best training results, the following personnel are required to conduct field firing:

(a) *Officer in charge.* He is responsible for the operation of the training range and for conducting a safety orientation prior to each scheduled period of instruction.

(b) *Range safety officer.* He is responsible for the safe operation of the range. He insures that all personnel comply with the safety regulations and procedures. This officer should not be assigned any duty except that of safety officer.

(c) *Noncommissioned officer in charge (NCOIC).* He is responsible for insuring that all enlisted personnel are capable of performing their assigned duties. He supervises the preparation of the training area and aids the OIC in overall supervision of the instructor and support personnel.

(d) *Control tower operators.* They are responsible for raising and lowering the targets, timing their exposures, sounding the ending signal, and giving the fire commands. If possible, two men should be designated to perform these functions. *Only the tower operator will give the command to commence firing.*

(e) *Ammunition detail.* It is responsible for distribution of ammunition to central points behind the firing line. This detail should not be confused with the ammunition men designated from among the firing order.

(f) *Ordnance detail.* It should be composed of two segments, one to conduct small arms repair and the other to perform minor maintenance on the automatic target devices.

(g) *Assistant instructor.* One assistant instructor is required per five to 10 points. He is responsible for insuring that all firing personnel observe safety procedure and regulations, and for assisting those firers having unusual difficulty in hitting the targets.

(h) *Medical personnel.* Provide medical support as required by regulations governing live fire exercises.

e. Range Procedures.

(1) *Orientation.* Prior to beginning live fire exercises, all personnel must receive an orientation on range safety. In addition, the orientation should

outline the procedures for conducting the exercise as include the responsibilities of the nonfiring orders. In general, these responsibilities are:

(a) *Scorers.* Responsible for maintaining the score of the firer. He may assist the firer by indicating the impact of the bullet in relation to the target; e.g., "short, right" or "over, left."

(b) *Ammunition men.* Issue ammunition to firers and, if necessary, fill empty magazines for subsequent exercises.

(2) *Master score chart.* A master score chart indicating individual scores for each exercise is an effective method of maintaining a competitive spirit within a unit. It also provides a means of identifying those individuals in need of closer supervision and/or corrective instruction.

(3) *Conduct of firing.* During field firing, soldiers will fire from both stationary positions and positions which they assume rapidly while moving forward. In either of these two types of exercises, targets may be exposed singly or in multiples of two or three. The positions of the firer, and the sequence, type, and time of target exposure are prescribed on the scorecard for each exercise. Unless prescribed otherwise, only one round should be fired at each exposed target regardless of whether or not it is hit.

Note. See ASubSed 23-72 for sample exercises and scorecards.

(a) *Stationary position exercise.* On command, firers assume the designated firing position and lock and load their rifles. The exercise begins on the command, **WATCH YOUR LANES.** At this time, firers unlock safeties and engage targets as they appear in their lanes. Firers remain in the same position unless told otherwise.

(b) *Movement-type exercise.* In order to conduct movement-type exercises, firers must be thoroughly familiar with the control points used to regulate the forward progress. These are the starting points, rear numbered stakes, stumps, foxholes, and the front numbered stakes (fig 83). To begin the exercise, firers move to the starting points and, on command, lock and load their rifles. Subsequent fire commands may or may not prescribe the firing position; however, the control point from which firing will be conducted must always be included in the command; e.g., **THE KNEELING POSITION BY THE REAR NUMBERED STAKE, MOVE OUT,** or, **BY THE FOXHOLE, MOVE OUT;** the firer begins walking slowly forward.

CAUTION: Firers must maintain alignment as they advance. Assistant instructors must closely supervise this movement to insure individual firers do not get ahead or behind the other firers. All firers must lock their weapons before they make the next movement.

As the line of firers near the designated control points, targets are exposed and each firer rapidly assumes the designated position and engages the exposed target(s) in his lane. Firers remain in this position and continue to observe their lane for other targets to appear. If the firing position is not designated, firers may select their own position.

(c) *Single and multiple target exercises.* For the first several exercises, targets are exposed singly in each lane and firers engage the targets in their respective lanes. Later in the training, multiple target exercises are conducted. During the conduct of multiple target exercises each firer will be presented a combination of 75-meter, 175-meter, and 300-meter target exposures.

Note. See appropriate scorecards in A5ub/Sec 23-72.

f. *Fire Commands.* Simple, standardized fire commands are essential to avoid confusion during field firing exercises.

(1) Fire commands for exercises from stationary positions.

- (a) FIRERS, ASSUME THE POSITION.
- (b) LOCK, _____ ROUNDS LOAD.
- (c) READY ON THE RIGHT?
- (d) READY ON THE LEFT?

(e) THE FIRING LINE IS READY.

(f) WATCH YOUR LANES.

(g) CEASE FIRE, LOCK YOUR WEAPON.

(h) Repeat (a) through (g) above or give (i) through (l) below.

(i) CEASE FIRING, CLEAR ALL WEAPONS.

(j) CLEAR ON THE RIGHT?

(k) CLEAR ON THE LEFT?

(l) THE FIRING LINE IS CLEAR.

(2) Fire commands for movement-type exercises. Before an initial exercise of this type, explain the use of control points and the need for maintaining alignment while advancing.

(a) FIRERS, MOVE TO YOUR STARTING POINT.

(b) LOCK, _____ ROUNDS LOAD.

(c) READY ON THE RIGHT?

(d) READY ON THE LEFT?

(e) THE FIRING LINE IS READY.

(f) LOCK YOUR WEAPON. BY THE (control point), THE (position), MOVE OUT. OR BY THE (control point), MOVE OUT.

Note. This command is repeated for each control point as prescribed on the scorecard.

TARGET DETECTION

Section I. GENERAL

64. Purpose

Even the most skilled marksmen is useless if he cannot find the target. For the combat rifleman, finding the target can be even more of a problem than hitting it. Except during the final stages of the assault, it is a rare soldier who fails to use some cover and/or concealment when he is in the vicinity of enemy units. Consequently, considerable emphasis must be placed on teaching soldiers the techniques of detecting targets as they will appear on the battlefield. As used in this manual, the term "target detection" means the process of locating, marking, and determining the range to combat targets. These targets may be either single or multiple, stationary or moving. They can also be completely hidden. The purpose of this chapter is to outline procedures for teaching soldiers how to detect enemy personnel on the battlefield under varying degrees of mobility, concealment, and visibility.

65. Training Concepts

Target detection training is based on concepts governing the usual behavior and employment of infantry units, and the individuals within those units on the battlefield. These concepts include:

- a. Enemy personnel are seldom seen except in the assault.
- b. The range at which individual enemy soldiers can be detected rarely exceeds 300 meters.
- c. Many indications can reveal the location of the enemy. Among the more common are movement, sounds of movement, sound and/or muzzle flash of a firing weapon, and the reflection of light from shiny objects. However, any of these indications will usually be sensed for only a brief time.
- d. A combat target does not have to be visible in order to be hit by rifle fire. An enemy soldier who has been observed moving into a concealed position can be effectively engaged by using a nearby feature as a reference point.

Section II. RANGE ORGANIZATION AND MANAGEMENT

66. Location

Since target detection training is usually conducted concurrently with other firing exercises, the target detection ranges should be located nearby (within 10 minute movement time of) the firing ranges. It is also essential that target detection ranges be located in areas having good natural vegetation (fig 85). The observation lines of target detection ranges must be placed on terrain which will approximate good defensive locations for units occupying that particular area.

67. Construction

a. The observation line should be among the first areas of the target detection range to be constructed. The reason for this is that the location of all down range panels, sound systems, and any necessary trimming of foliage depends on the degree of visibility from the observation line. The observation line should be wide enough to accommodate 50 points. The distance between observation points should be no closer than 2 meters.

An observation line of this size is sufficient to accommodate half of a 200 man unit (50 two-man teams).

b. The fan of observation should cover an area between 30 degrees left of the left flank point of the observation line to 30 degrees right of the right flank point. Ideally, to provide maximum flexibility in conducting exercises in range determination, the target detection ranges should have a depth in excess of 500 meters. Installations having limited training space can conduct satisfactory training on ranges having a depth of at least 300 meters.

c. Both lettered and numbered panels are placed throughout the observation area. The lettered panels serve two purposes: first, they divide the range into sectors defining a rifleman's area of responsibility; and second, they serve as reference points for marking targets. The numbered panels are used during exercises to locate sound targets only. Consequently, these panels should be constructed so they can be easily raised or lowered as required.

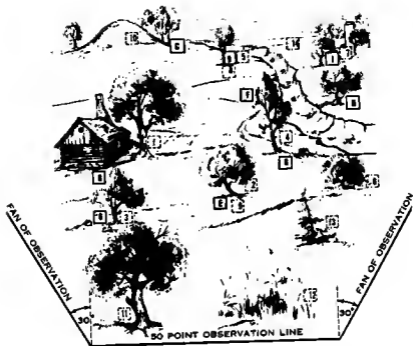

Figure 85. Target detection range.

d. The number of panels needed depends upon the size of the range. For a range having a 50-point observation line and a depth of 300 meters, approximately seven lettered panels and 14 numbered panels will be required.

e. In addition to the panels, numbered stakes are placed down range. These stakes should not be visible from the observation line since they are for use only by instructors and target men in presenting various target situations. As in the case of the panels, the number of stakes required will depend upon the depth of the range. As a guide, a range having a depth of 300 meters should have approximately 150 stakes. In placing numbered stakes a method should be used to provide easy reference to stake locations. One such method is to divide the range into three sectors, A, B, and C. Stakes are then numbered beginning at the maximum depth of the range and proceeding forward to the observation line. All stakes in one

sector would have the sector letter following the number. For example, if the right sector is designated A, all numbers on stakes in that sector will be followed by the letter A. Stakes in the center and left sectors will have the letter B and C, respectively, after the number.

f. The location of all panels and stakes must be recorded on the master trial sheets (fig 86).

g. For proper control of target men, it is necessary to use sound equipment throughout the observation area. Since problems of adequate sound vary according to location, it is best that a sound survey be conducted of each target detection range before the equipment is installed.

h. The exact positioning of panels, stakes, and sound equipment should be checked from the observation line. It is desirable that sound equipment be concealed from the observation line; however, this is not an absolute necessity.

Trial No.	Range (meters)	Target man	Description of requirements
1	200	1	Standing exposed by tree. Down to kneeling, exposed. Slow movement to out-of-sight position. Out-of-sight fire round for smoke indications. Stake 1A.
2	150	2	Same as above with a poor aiming point. Stake 3B.
3	175	3	Start standing. Disappear on command. Reappear in prone position. Make five 4-second rushes with a good aiming point. Fire one round from last position. Stakes 2C-3C-4C-5C-6C-7C.
4	300	1	Start from kneeling position behind bush. Make five 4- to 5-second rushes. Disappear when there is a poor aiming point. Reappear from same position. 5-3-3-5-seconds. Fire round from last position. Stakes 1A-2A-3A-4A-5A-6A.
5	300	2	Start prone. Make five 4-5-8-second rushes. Disappear after each rush and crawl or creep to new position. Three-second rush, crawl left. Six-second rush, rush, crawl right. Crawl small draw. Appear and make 5-second rush, crawl left. Three-second rush, crawl right. Fire one round from last position. Stakes 3B-4B-5B-6B-7B-8B.
6	175	3	Start prone. Make three 4-second and two 8-second lateral rushes to new concealment. Reappear at same point of disappearance. Vary time between rushes. Fire one round from last position. Stake 7L-8L-9L-10C-11C-12C.
7	175	3	Do same in reverse. Crawl or roll to new position after disappearing. Fire round from last position. Stakes 12C-11C-10C-9C-8C-7C.
8	200	1	Run 200 yards from tree to position with a poor aiming point. Fire two blasts 1 minute after disappearance. Stake 6A-11C.
9	300	2	Start prone. Three-second rush, crawl left. Five-second rush, crawl right. 5-L-3-3-6-R-4-3, through draw. Fire round from last position. (Numbers indicate duration of rush; letters L and R indicate direction of roll or crawl) after each rush. Stakes 8B-9B-10B-11B.
10	300	3	Start behind bush. 6-8-R-3-B-4-3. Fire round from last position. Stakes 7L-9L-10L-11L-12C.

Note: Target trial sheet should be prepared from a master trial sheet similar to the one above containing only the trials and target indication times performed by a specific target.

Figure 86. Sample master trial sheet.

68. Use of Field Expedient Area for Target Detection Training

If standard target detection ranges are not available, the principles can be applied in parks, open fields, or other sparsely vegetated areas. The following considerations provide a checklist when adapting such areas for target detection training:

a. There should be more depth to the range than for a standard target detection range. In addition, the fan of observation should be increased depending on the degree of camouflage in the area.

b. Target men should be spaced wider apart in areas having little natural vegetation. In this regard, it may even be necessary to bring in piles of brush, logs, and manmade objects to add to the number of concealed positions.

69. Range Personnel and Equipment

a. The following personnel are required to conduct and supervise target detection training:

- (1) Officer in charge and/or principal instructor.

- (2) Four assistant instructors (based on a 50-point observation line).

- (3) Target men as required for the period of instruction.

- (4) Medical personnel.

b. The following equipment is required to conduct target detection training:

- (1) One master trial/answer (fig 86) sheet per instructor and assistant instructor.

- (2) One target trial card per target man (fig 87).

- (3) One answer sheet per observer.

- (4) One aiming device per observation point as required for the period of instruction (fig 88).

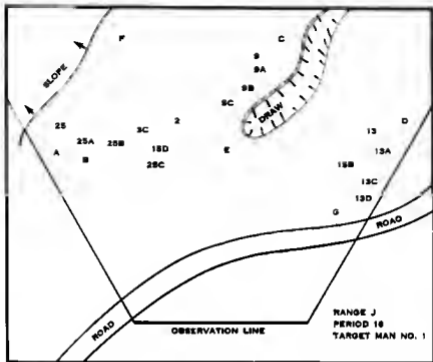

1 Foot
Figure 87. Target trial card.

TARGET MAN NO. 1

TRIAL NO.

1
5
5
8

STAKE LOCATION

2
25-25A-25B-3C-15D-25C
15-15A-15B-15C-15D
9-9A-9B-9C

TRIAL

(PHASE)

ACTIONS

- | | | |
|----|----|--|
| 1- | 1- | MOTIONLESS IN PRONE POSITION |
| | 2- | SLOWLY RAISE AND LOWER HEAD AND SHOULDERS |
| | 3- | SLOWLY RAISE HEAD AND SHOULDERS. DROP ABRUPTLY |
| | 4- | FIRE TWO BLANKS |

S-RUN TO EACH POSITION. AWAIT COMMANDS TO STAND, DISAPPEAR, AND MAKE NEXT MOVEMENT.

S-CRAWL TO EACH POSITION. AWAIT COMMANDS TO STAND, DISAPPEAR, AND MAKE NEXT MOVEMENT.

S-RUN TO EACH POSITION, STOPPING TWO SECONDS AT EACH.

RANGE J

PERIOD 18

2 Back
Figure 87—Continued.



Figure 88. Aiming device.

Section III. CONDUCT OF TRAINING

70. Training Conditions

Demonstrators for target detection training wear combat field equipment to increase their value as target men simulating the movements and appearance of enemy soldiers.

71. Fundamentals of Target Detection

Initially, target detection is taught in three distinct phases: first, how to locate a target; second, how to mark the location of the target; and third, how to determine the range to the target. Later, these phases are combined into practical exercises which test the overall target detection ability of the soldier.

a. *Locating Targets.* The ability to locate a combat target depends upon the observer's

(5) Camouflage paint tubes as required.

(6) For exercises in which observers simulate firing on target men, there should be one rifle (which has had the firing pin removed) per observation point.

(7) Target men should have their normal combat field equipment including steel helmet and rifle.

position, his skill in search and/or maintaining observation over the area, and the type of indications made by the target.

(1) Selection of a position.

(a) Depending upon the situation, the individual rifleman may or may not select his own position. In most defensive situations, the rifleman is told where to prepare his position. However, there are situations such as the attack and reorganization on the objective which require the individual to select his own position. Although target detection training courses prescribe conference and demonstrations on selection of positions, the instruction does not normally include practical application of this skill. Consequently,

Instructors must continuously refer to and emphasize the importance of the observer's position when conducting practical exercises in other target detection techniques.

(b) A good position is one that offers maximum visibility of the area while affording cover and / or concealment. As used in this case, "position" is both the observer's location on the ground and the position of his body at that location.

12) *Searching and maintaining observation of an area.*

(a) When a soldier moves into a new area, he must quickly check for enemy activity which may be of immediate danger to him. This is a very rapid search, lasting approximately 30 seconds and known as the self-preservation method of search. The search should be conducted by making quick glances at specific points throughout the area rather than just sweeping the eyes across the terrain in one continuous panoramic view. The reason for this is that the eyes are sensitive to slight movements occurring within the arc on which they are focused. This is commonly called "seeing out of the corner of the eye." However, **THE EYES MUST BE FOCUSED ON A SPECIFIC POINT IN ORDER TO HAVE THIS SENSITIVITY.**

(b) If the soldier fails to locate the enemy during the initial search, he must then begin a systematic examination known as the 50-meter overlapping strip method of search (fig. 29). Normally, the area nearest the soldier offers the greatest potential danger to him. Therefore, the

search should begin with the terrain nearest the observer's position. Beginning at either flank, the soldier should systematically search the terrain to his front in a 180° arc, 50 meters in depth. After reaching the opposite flank, the soldier should search over a second 50 meter strip farther out but overlapping the first strip by approximately 10 meters. The soldier continues in this manner until the entire area has been searched.

(c) To again take advantage of his side vision, the soldier should focus his eyes on specific points as he searches from one flank to the other. He should make mental notes of prominent terrain features and areas that may offer cover and / or concealment to the enemy. In this way, he becomes familiar with the terrain as he searches it.

(d) After completing his detailed search, the soldier may be required to maintain observation of the area. To do this, he should use a method similar to his initial quick search of the area. That is, he uses quick glances at various points throughout the entire area, focusing his eyes on specific features as he conducts this search. He should devise a set sequence of searching the area to insure complete coverage of all terrain. Since it is entirely possible that this quick search may fail to detect the initial movement of an enemy, the observer should periodically repeat a systematic search of the area as described in (b) above. This systematic search should also be conducted anytime the attention of the observer has been distracted from his area of responsibility.



Figure 89. Searching the terrain in overlapping strips

121 **Target indications.** A target indication is anything a soldier (friendly or enemy) does or fails to do that will reveal his position. Since these indications apply equally to both sides of the battlefield, a soldier must learn target indications from the standpoint of locating the enemy but, at the same time, preventing the enemy from using the same indications to locate him. These indications can be grouped into three general areas for instructional purposes: sound, movement, and improper camouflage.

(a) **Sound.** Targets indicated by sounds such as footsteps, coughing, or equipment noises provide only a direction and general location. Consequently, it is difficult to pinpoint a target's location by sound alone. However, the fact that a

sound has alerted an observer greatly increases the possibility that he will eventually locate the target through subsequent target indications.

(b) **Movement.** The degree of difficulty in locating moving targets depends primarily on the speed of movement. Slow, deliberate movements are much more difficult to notice than those which are quick and jerky. The techniques outlined in (21 (a) above are the best procedures for locating moving targets.

(c) **Camouflage.** The lack or improper use of camouflage and/or concealment are indications which reveal the majority of targets detected on the battlefield. Such things as light reflecting from shiny surfaces or a contrast with the background presenting a clearly defined outline are indicators

easily noticed by an alert observer. For instructional purposes, camouflage indicators are divided into three general groups: shine, regularity of outline, and contrast with background.

1. *Shine.* Items such as belt buckles or other metal objects reflect light and act as a beacon to the wearer's position. This is as true at night as it is during the day. Consequently, objects which reflect light should be camouflaged.

2. *Regularity of outline.* The human body and most types of military equipment are familiar outlines to all soldiers. The outlines of such things as rifles, steel helmets, and vehicles are all easily identified. The reliability of this indicator depends upon the visibility and the experience of the observer. On a clear day most soldiers can easily identify enemy riflemen or equipment if a distinctive outline is presented. At night or during other periods of poor visibility, it is not only more difficult to see outlines, but inexperienced troops will frequently mistake stumps and rocks for enemy soldiers. This is an added reason for soldiers to become completely familiar with the terrain during periods of good visibility.

3. *Contrast with the background.*

(a) Suppose a soldier wearing a dark uniform moved into a position in front of a snowbank. The contrast between the white snow and the dark uniform would make him clearly visible. However, if he were wearing a white (or light colored) uniform, he would be more difficult to see. *Contrast with the background is among the most difficult of the target indicators for a soldier to avoid.* The reason for this is that during operations in which the soldier is moving, he is usually exposed to numerous types of colors of backgrounds. Since there is no one kind of personnel camouflage which blends in all areas, a moving soldier must be continually aware of the surrounding terrain and vegetation.

(b) *Contrasts in background* are a common deficiency of defensive positions. A parapet of freshly dug earth around a foxhole is noticeable. Even if the position is camouflaged, it is still possible to locate it from the very materials used to provide concealment. For example, a hill having no vegetation except a row of equally spaced bushes along the crest may leave little doubt in an observer's mind as to the presence of defensive positions. Even camouflage which blends with the area can indirectly disclose a position. Since camouflage materials are usually cut from vegetation within the immediate vicinity, an observer seeing an area which has been stripped of natural growth can logically deduce the presence of nearby camouflaged emplacements. Another problem of using vegetation for camouflage is that it will eventually wilt and change color. This

produces a contrast similar to those positions having no camouflage at all.

b. *Marking Targets.*

(1) Once a target has been located, the soldier may have to mark its location in relation to some visible terrain or manmade feature. There are several reasons for this. The enemy may have only briefly disclosed his position before again becoming hidden from view. In some situations the rifleman may be under orders not to fire and thereby possibly disclose his position. Probably the most common reason is that if the soldier observes several targets at the same moment, he can obviously fire on only one of them at a time. Consequently, he must mark the location of the others until he is ready to engage them.

(2) To mark the location of a target, the soldier uses an aiming point or a reference point. An aiming point is a feature directly on line between the soldier and the target. For example, suppose a soldier observes an enemy rifleman moving into a completely concealed position behind a bush. By selecting a point of aim on the bush, the soldier should hit the enemy rifleman even though he can't see him. However, suppose the enemy rifleman moves into a concealed position which has no distinguishable feature in front of it. The soldier must then select a nearby feature as a reference point and determine its distance and general direction from the target. Of the two, an aiming point is usually the more effective means of delivering accurate fire.

(3) The difficulty in using reference points or aiming points to mark targets moving from one location to another depends on the factors listed below.

(a) *Number of targets.* If several targets appear and disappear at approximately the same time, it is very difficult to note the point of disappearance of each.

(b) *Exposure time of target.* Usually, moving targets are exposed for only a short period of time. Thus, the observer must be alert to note the point of disappearance for all of the targets. In such situations the soldier should mark the location of as many targets as possible before engaging any of them. By so doing, he will know the location of several targets and can engage each of them in rapid succession.

(c) *Spacing of targets.* The greater the interval between targets, the more difficult it is to note the movements of each. When there is considerable distance between targets, the observer should accurately locate and mark the one nearest his position and note the general area of the others.

(d) *Good and poor aiming points.* Good aiming points are easily distinguishable in the surrounding terrain. Targets disappearing behind

good aiming points such as manmade objects, large terrain features, and the like, can be marked for future reference. Poor aiming points are not easily distinguishable within the surrounding terrain. Targets disappearing behind poor aiming points are difficult to mark accurately and are easily lost. If two targets offer about the same degree of danger to the soldier, but one disappears behind a good aiming point and the other behind a poor aiming point, the soldier should mark the location of the target behind the good aiming point and engage the other target first.

c. *Determining Range.*

(1) Simply stated, range determination is the process of finding the distance between two points. In most situations one of these points will be the observer's own position. The other point may be a target or prominent feature. **THE ABILITY TO ACCURATELY DETERMINE RANGE IS AN IMPORTANT SKILL NEEDED BY THE COMBAT RIFLEMAN TO ACCOMPLISH HIS MISSION.** Not only does the accuracy of range affect his combat marksmanship proficiency, but it is also required in the reporting of information and the adjustment of artillery and mortar fire.

121 There are a number of methods for determining range: measuring distances on maps, pacing the distance between two points, using an optical range finder, and firing a round at the point in question. However, the combat rifleman does not usually have a map, and he rarely has access to an optical range finder. Pacing the distance between two points is one method a soldier can use, provided the enemy is not in the vicinity. Firing a round to determine the range is usually not desirable since it immediately reveals the firer's presence and possibly his position. There are two methods of determining range which do not have the above disadvantages: the 100-meter-unit-of-measure method and the appearance-of-objects method.

(a) *100-meter-unit-of-measure method.*

1. To use this method, the soldier must be able to visualize a distance of 100 meters on the ground. For ranges up to 500 meters he determines the number of 100-meter increments between the two points (fig. 90). Beyond 500 meters the soldier must select a point halfway to the target, determine the number of 100-meter increments to the halfway point, and then double it to find the range to the target (fig. 91).

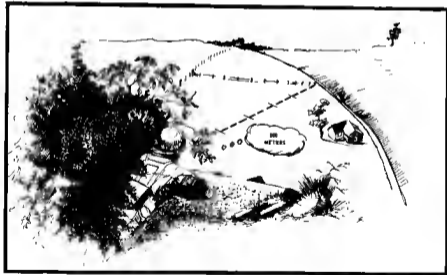

Figure 90. The 100-meter-unit-of-measure method; ranges UP TO 500 meters.

2. During training exercises the soldier must become familiar with the effect that sloping ground has on the appearance of a 100-meter

increment. Ground which slopes upward gives the illusion of greater distance and observers have a tendency to underestimate a 100-meter increment.

Conversely, ground which slopes downward gives the illusion of shorter distance. In this case, the observer's tendency is to overestimate.

3. Proficiency in the 100-meter-unit-of-measure method requires constant practice. Throughout the training in this technique, comparisons should be made continually between the range as determined by the soldier and the actual range as determined by pacing or other more accurate means of measurement. The best training technique is to require the soldier to pace the range after he has visually determined it. In this way he discovers the actual range for himself, which makes a much greater impression than if he is simply told the correct range.

4. The greatest limitation of the 100-meter-unit-of-measure method is that its accuracy is directly related to the amount of terrain visible to the observer. This is particularly true at longer ranges. If a target appears at a range of 500 meters or more and the observer can see only a portion of the ground between himself and the target, it becomes very difficult to use the 100-meter-unit-of-measure method of range determination with any degree of accuracy.

(b) Appearance-of-objects method.

1. The appearance-of-objects method is a means of determining range by the size and other characteristic details of the object observed. This is a common method of determining distances and is used by most people in their everyday living. For example, a motorist attempting to pass another car must judge the distance of oncoming vehicles based on his knowledge of how vehicles appear at various distances. Of course, in this example, the motorist is not interested in precise distances, but only that he has sufficient road space to safely pass the car in front of him. Suppose, however, the motorist knew that at a distance of 1 mile an oncoming vehicle appeared to be 1 inch wide and 2 inches high, with about a half an inch between the headlights. Then, any time he saw other oncoming vehicles which fitted these dimensions he would know they were about 1 mile away. This same technique can be used by riflemen to determine ranges on the battlefield. If he knows the characteristic size and detail of personnel and equipment at known ranges, then he can compare these characteristics to similar objects at unknown ranges. When the characteristics match, so then do the ranges.

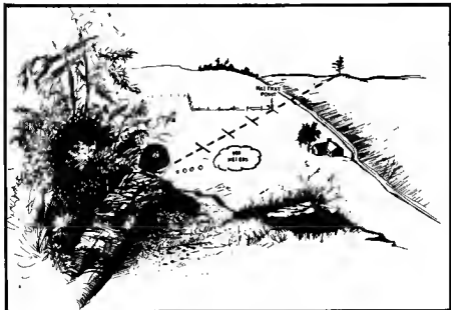

Figure 91. The 100-meter-unit-of-measure method; ranges OVER 500 meters.

2. To use the appearance-of-objects method with any degree of accuracy, the soldier must be thoroughly familiar with the characteristic details of objects as they appear at various ranges. For example, the soldier should study the appearance of a man when he is standing at a range of 100 meters. He fixes the man's appearance firmly in his mind, carefully noting details of size and the characteristics of uniform and equipment. Next, he studies the same man in a kneeling position and then in a prone position. By comparing the ap-

pearance of soldiers in these positions at known ranges from 100 to 500 meters, the soldier can establish a series of mental images which will help him determine range on unfamiliar terrain. Training should also be conducted in the appearance of other familiar objects such as weapons or vehicles. Because the successful use of this method depends upon visibility, anything which limits the visibility (such as weather, smoke, darkness) will also limit the effectiveness of this method (fig 92).

FACTORS TO BE CONSIDERED IN DETERMINING RANGE BY EYE	OBJECTS APPEAR NEARER THAN THEY REALLY ARE.	OBJECTS APPEAR MORE INSTANT THAN THEY REALLY ARE.
THE TARGET — ITS CLEARNESS OF OUTLINE AND DETAILS.	WHEN MOST OF THE TARGET IS VISIBLE AND OFFERS A CLEAR OUTLINE.	WHEN ONLY A SMALL PART OF THE TARGET MAY BE SEEN OR IS SMALL IN RELATION TO ITS SURROUNDINGS.
NATURE OF THE TERRAIN OR POSITION OF THE OBSERVER	WHEN LOOKING ACROSS A DEPRESSION, MOST OF WHICH IS HIDDEN FROM VIEW WHEN LOOKING DOWNWARD FROM HIGH GROUND. WHEN LOOKING DOWN A STRAIGHT, OPEN ROAD OR ALONG A RAILROAD TRACK.	WHEN LOOKING ACROSS A DEPRESSION, ALL OF WHICH IS VISIBLE. WHEN LOOKING FROM LOW GROUND TOWARD HIGH GROUND. WHEN FIELD OF VISION IS NARROWLY CONFINED AS IN TWISTED STREETS, BEANS, OR FOREST TRAILS.
LIGHT AND ATMOSPHERE.	WHEN LOOKING OVER UNIFORM SURFACES LIKE WATER, SNOW, DESERT, OR GRAIN FIELDS. IN BRIGHT LIGHT OR WHEN THE SUN IS SHINING FROM BEHIND THE OBSERVER WHEN THE TARGET IS IN SHARP CONTRAST WITH THE BACKGROUND OR IS SILHOUETTED BY REASON OF SIZE, SHAPE, OR COLOR. WHEN SEEN IN THE CLEAR ATMOSPHERE OF HIGH ALTITUDES.	IN POOR LIGHT SUCH AS RAIN AND DUST, IN RAIN, SNOW, OR FOG, OR WHEN THE SUN IS IN THE OBSERVER'S EYES. WHEN THE TARGET BLEND INTO THE BACKGROUND OR TERRAIN.

Figure 92. Factors affecting the appearance of objects.

(c) Under proper conditions, either the 100-meter-unit-of-measure or the appearance-of-objects method is an effective way of determining range. However, proper conditions do not always exist on the battlefield. Consequently, the soldier will be required to use a combination of methods. The terrain might limit the use of the 100-meter-unit-of-measure method and the visibility might limit the use of the appearance-of-objects method. For example, an observer may not be able to see all of the terrain out to the target; however, he may see enough to get a general idea of the distance, say, within 100 meters. A slight haze may obscure many of the target details; however, the observer should still be able to judge its size. Thus, by carefully considering the approximate ranges as determined by both methods, an experienced observer should arrive at a figure close to the true range.

(d) A sector sketch is a rough schematic

map of an observer's area of responsibility (fig 93). It shows the range and direction from the observer's position to easily recognizable objects, terrain features, avenues of approach, and possible enemy positions. If practicable, the observer should pace the distance between his position and reference points in order to minimize range errors. By referring to this sketch, the observer can quickly find the range to a target appearing in the vicinity of a reference point.

72. Engaging Targets

Unless a rifleman has specific orders to the contrary, targets are engaged as soon as they are detected. In the case of enemy personnel, there are essentially three types of target situations which confront the rifleman: a stationary target, a slowly moving target, or a rapidly moving target.

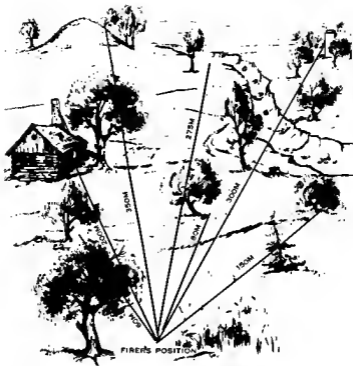

Figure 93. Sector sketch.

a. A stationary target can be engaged using reference or aiming points. Since a stationary target normally is in a concealed position, engaging it is usually as much a problem of target detection as it is of marksmanship.

b. Although there are less detection problems involved in locating moving targets, the movement itself complicates the selection of an accurate aiming point. Unless the enemy is completely unaware of the rifleman's presence, he normally will move by rushes from one covered or concealed position to another. While making the rush, the enemy soldier presents a rapidly moving target. However, for a brief moment as he begins and ends the rush, the movement is usually slow. The reason for this is that a few steps are needed to gather momentum to begin the rush; and, by the same token, a few steps are required to slow down to avoid overrunning the new position. It is at either of

these two moments that a moving target is most vulnerable to aimed rifle fire.

c. A target moving directly toward the rifleman can be engaged in the same manner as a stationary target. However, to hit a target moving laterally across his front, the rifleman must aim far enough in advance of the target so the bullet will meet the target (fig 94). To hit a man walking laterally at ranges of 200 meters and less, the rifleman should aim at the forward edge of the body. For ranges beyond 200 meters the rifleman should select an aiming point approximating one body width in front of the target. If the target is running, these target leads are doubled. That is, at ranges of less than 200 meters the rifleman aims approximately one body width in front of the target, and beyond 200 meters he aims approximately two body widths in front of the target.

Note. For targets moving either away from or toward the firer at an oblique angle the firer would take one-half the

number of leads normally taken for the same target moving laterally.



Figure 96. Target leads.

73. Trial Sheets

a. *Master Trial Sheets.* The master trial sheet (fig 86) shows the number of target men required for an exercise, the actions to be performed by the target men, the duration of the actions, and the panel or stake locations where the actions will occur. A master trial sheet should be made for each period of instruction.

b. *Target Trial Cards.* A target trial card (fig 87) is issued to each man who will act as an enemy target in the area of observation. These men, called "target men," use the target trial cards as a basis for their location and actions throughout an exercise. All actions performed by a target man,

which leads to his eventual disclosure are termed a "trial."

74. Conduct of Trials

Before a trial is conducted, observers should face away from the range area so target men can assume their positions unobserved. When the target men are in position, the observers are told to again face down range. There are four types of trials conducted during target detection training. These are stationary trials, moving trials, stationary sound trials, and multiple moving and sound trials.

a. *Stationary Target Trials.* Normally, there are four phases in each stationary trial. The first three

phases last 30 seconds each. In *phase one* the target man remains motionless in a slightly posed position that will enable him to observe the heads and chests of soldiers along the observation line. In the *second phase* the same target man slowly raises his head and shoulders until he can observe the soldiers on the observation line from the ground up. In *phase three* the same target man makes rapid, jerky movements continuously for 30 seconds. Finally, in *phase four* the same target man fires one or two blank rounds toward the observation line (safely permitting). The command to begin a stationary target trial is **TRIAL ONE, PHASE ONE, OBSERVE**. If, during the first phase, the observer thinks he has located the target, he notes the letter of the panel nearest the target and determines the range from his position to the target. He enters this information on his answer sheet and an assistant instructor checks his solution. A range error of not more than 10 percent is considered satisfactory. If the observer has selected the wrong panel or the error in range exceeds 10 percent, he should be told his answer is incorrect and to continue his observation. If the answer is correct, the observer should continue his observation of the area, recording the required information on his score sheet for the subsequent phases. This procedure is followed throughout the four phases of stationary trials.

Note. For more detailed information see Appendix D, periods 1 and 2.

b. Moving Target Trials.

(1) The target trial cards for moving trials must indicate the specific trials in which the target man will participate, the stake location at which he begins the trial, the stake location to which he must move, and finally, the type movement and/or other specific actions to be performed by the target man. For example, the target trial card for target man No. 1 might indicate that he would participate in trials 1, 5, 6, and 8. In trial one the instructions state that he will perform four phases of a stationary target exercise. In trial five he is told to make five short rushes from stake 25 to stake 25C.

(2) In order to check the accuracy of observers, aiming devices should be used to mark the points of disappearance of multiple moving targets (fig 48). The observer simply aligns the two sight knobs on the aiming device where he thinks the targets are located. Normally, two soldiers are assigned to an aiming device, one to act as the observer and the other to check the observer's work.

(3) To begin a moving trial, the command is **MOVING TARGETS; STAND UP; DISAPPEAR AND BEGIN YOUR MOVEMENTS**. On these commands the applicable target men reveal

themselves to the observers, move back into their concealed positions, and begin the movements as directed on their target trial cards. During some exercises the target men may fire blank rounds after reaching a new location. Observers are allowed 30 seconds to mark the point (s) of disappearance with the aiming device. The instructor then commands **TARGETS STAND UP, ALTERNATE OBSERVERS CHECK ALINEMENT**. The observer then checks the accuracy of his work. This procedure is continued until all of the trials have been conducted.

Note. For more detailed information see appendix D, periods 3, 4, and 6.

c. *Sound Target Trials.* Before the trials begin, the observers should draw a sector sketch of the area. All of the numbered panels should then be raised for sound target trials. Each target man occupies a concealed position in the vicinity of one of the numbered panels. The instructor then informs the observer that a shot will be fired from one of the numbered panels. The observers must determine the panel location nearest the sound and record the information on their answer sheets. The commands to conduct the exercise are: **TRIAL NUMBER (ONE); READY, AIM, FIRE. OBSERVERS RECORD YOUR ANSWERS**. Should it be necessary to reposition target men for subsequent trials, the observers should flee away from the range while the movement is taking place. In some trials two target men should fire simultaneously in order to demonstrate the difficulty in locating similar sounds coming from two directions at the same time.

Note. For more detailed information see appendix D, period 5.

d. *Multiple Moving and Sound Targets.* To conduct multiple moving and sound target exercises, eight target men are required (two 4-man teams). Observers are divided into two groups with each pair having one aiming device. The command to begin the exercise is **MOVING TARGETS STAND UP; DISAPPEAR AND BEGIN YOUR MOVEMENT**. The moving target men reposition themselves, assume their concealed positions, and begin their rushes forward. After making their move, some of the target men should fire one or more blank rounds. The observer uses the aiming device to mark the point of disappearance of as many moving targets as possible. Upon completing a trial, the instructor commands **TARGETS STAND UP, CHECK ALINEMENT**. At this time the target men stand up and the alternate observer checks the accuracy of the observer's work. In the next trial the alternate observer becomes the observer and the observer becomes the alternate observer.

Note. For more detailed information see appendix D, period 7.

75. Target Detection Tests

At the final stage of this target detection training, soldiers should be tested on their ability to detect and determine ranges to single stationary targets, marking the points of disappearance of single and multiple moving targets, and locating targets by sound.

a. *Test Number One—Stationary Targets.* Test number one is conducted using the same four phases prescribed for the target detection trials of stationary targets. In this case the observer receives points in proportion to the number of phases needed to detect the target. If the observer detects the target in phase one, he receives four points; in phase two, three points; and so on down to zero points if he fails to detect the target after four phases. To be considered correct, the observer must again select the lettered panel nearest the target and then determine the range from his position to the target. A range error of 10 percent or less is considered satisfactory. Master trial sheets, target cards, and range procedures are the same as prescribed for the practical exercises in detecting stationary targets. Each observer should be given approximately 16 trials involving detection of stationary targets in order to provide enough information to adequately judge his ability.

Note. For more detailed information see appendix D, period 8.

b. *Test Number Two—Moving Targets.* Target detection test number two requires the observer to mark the points of disappearance of multiple moving targets. These tests are conducted in the same manner as the practical exercises for moving targets (para 74 b). After the target men have completed their movements, observers are allowed 30 seconds to mark the points of disappearance, using the aiming device. Assistant instructors check the results and award one point for each correctly marked target location.

Note. For more detailed information see appendix D, period 9.

c. *Test Number Three—Sound Targets.* Test number three involves sound targets only. The test is conducted in the same manner as practical exercises for locating sound targets (para 74 e). On command, one or two target men fire their rifles, and the observer attempts to locate the sound, using the numbered panels as reference points. One point is awarded for each correct answer.

Note. For more detailed information see appendix D, period 9.

Section IV. CRACK AND THUMP TECHNIQUE

76. Definitions

a. The term "crack" as used in this section refers to the sound of a projectile (exceeding the speed of sound) as it passes near the individual.

b. The term "thump" as used in this section refers to the sound caused by the expanding gases escaping into the atmosphere when a weapon is fired.

77. Objective and Standards

The objective of crack and thump target detection training is to insure that all soldiers can effectively determine the location of and the range to a concealed target engaging them with fire. Units must conduct sufficient training under varying conditions of weather and visibility to insure effective target detection under all climatic conditions. During training the soldier should be able to determine the location of the target within 10 meters, 60 Percent of the time.

78. Training Facilities

a. *Range Terrain.* A crack and thump target detection range is a live firing range and should be constructed on terrain that slopes downward for approximately 500 meters and then slopes upward for an additional 200 meters. The natural vegetation should be removed only if it creates a safety hazard. A range layout is shown in figure 95.

b. Range Facilities.

i. *Communications.* A central switchboard should be located at the instructor/student location. The principal instructor must have a primary and secondary means of communicating with each rifle position, the safety officer, and the medical aid personnel.

ii. *Rifle cradler.* Each weapon must be placed in a secure weapons cradle, and when locked into position the weapon must have no horizontal or vertical movement.



Figure 95. Crack and thump target detection range.

c. *Weapons Requirements.* A minimum of 12 rifle positions (cradles) should be prepared. When the weapon is secured in the cradle, the trajectory must not be less than 20 feet above the highest position at which a student will be located. Every weapon used for this instruction should be in-

spected by local ordnance to insure it does not exceed the authorized bore tolerance.

d. *Ammunition.* Only ammunition that has been certified by the local ordnance technicians as being approved for overhead fire may be used.

79. Training Policies

a. *General.* The first series of trials conducted should be critiqued by the instructor to insure that each soldier thoroughly understands the principles of applying the crack and thump technique of locating a concealed target. Then as many trials as time permits may be conducted to test the soldier's proficiency.

b. *Technique of Crack and Thump.* The soldier must understand that when an enemy soldier engages him with semiautomatic or automatic fire, the first sound that he will hear is the crack(s) of the projectile(s) as it passes nearby. The next sound(s) that he will hear is the thump(s) which is the compressed gases escaping from the muzzle of the weapon into the atmosphere. Therefore, by mentally aligning the crack(s) with the thump(s), the soldier can determine the direction of his target (location of enemy firer).

c. *Crack and Thump Range Determination.* In addition to determining the direction to the target, the soldier must also determine the range to the target. This is accomplished by using the rapid count method. The rapid count method is conducted by the soldier starting his count when he hears the crack and continues until he hears the thump. This count is conducted at a fast rate of five counts per second. If the soldier is engaged by automatic fire, he starts his count on the last crack and ends it on the last thump. The count obtained is multiplied by 100 and this gives him the range to the target in hundreds of meters. This method of range determination may be used in conjunction with the 100-meter-unit-of-measure method or the appearance-of-objects method of range determination to obtain the ground distance to the target.

AUTOMATIC RIFLE MARKSMANSHIP

80. General

a. This chapter is a guide for personnel conducting automatic rifle marksmanship training with the M14A1, and the M14 with selector and M2 bipod (hereafter referred to as the M14 modified).

b. The automatic rifleman must frequently employ his weapon in the semiautomatic role for maximum effectiveness of fire. Therefore, proficiency in automatic rifle marksmanship requires that the individual has satisfactorily completed rifle marksmanship training. Training in automatic rifle marksmanship is intended to further develop skill in firing semiautomatically and to emphasize in the soldier's mind that the automatic rifle need not always be employed in the automatic role.

c. Fundamentals of automatic rifle marksmanship do not conflict in any way with those taught in semiautomatic rifle marksmanship training. The skills of rifle marksmanship are used by the automatic rifleman with only slight variation. Because of the nature of automatic fire and the decreased maximum effective range, additional skills are needed by the automatic rifleman if he is to become proficient in the employment of the automatic rifle. These include:

- (1) A more stable body position when employing the weapon in the automatic role.
- (2) Proficiency in rapid and systematic magazine handling.
- (3) Distribution of fire.
- (4) Additional knowledge on operation of the rear sight.

d. The degree of proficiency attained by the automatic rifleman will be largely dependent upon correct instruction and the correct application by the soldier of each fundamental of automatic rifle marksmanship. These fundamentals must be mastered by the soldier to insure a high degree of proficiency in the employment of the automatic rifle. They are:

- (1) The integrated act of automatic rifle shooting.
 - (a) Aiming.
 - (b) Steady hold factors.
- (2) Positions.
- (3) Automatic fire.
- (4) Magazine changing.
- (5) Fire distribution.

81. Right-Handed Firing

The M14A1 automatic rifle should be fired from the right shoulder. The primary reason for this is that the stabilizer assembly, which is attached over the flash suppressor of the rifle, is designed to compensate for the dispersion characteristics of right-handed firing only. This dispersion pattern is generally high and to the left for the average right-handed firer (dispersion pattern for left-handed firers is generally high and to the right).

82. Integrated Act of Automatic Rifle Shooting
Automatic rifle firing is an integrated act involving the simultaneous application of aiming and steady hold (holding the weapon steady).

a. *Aiming.* Aiming in automatic rifle firing is the same as that taught in semiautomatic rifle marksmanship training (although the soldier has been taught aiming in semiautomatic rifle marksmanship training, it must be reemphasized in his instruction on the automatic rifle).

b. *Steady Hold.* Steady hold is the technique of holding the automatic rifle as stable as possible while aiming the sights and firing the weapon. Steady hold in automatic rifle marksmanship is somewhat different than that taught in rifle marksmanship, and must be analyzed from two aspects:

- (1) Steady hold when firing from the unsupported positions (kneeling, kneeling supported [without use of bipod], and standing positions).
- (2) Steady hold when firing from the bipod supported positions (the prone and foxhole positions).

c. *Steady Hold Factors (Unsupported Positions).* When firing from the kneeling, kneeling supported (without use of bipod), and standing positions, semiautomatic fire in these positions are the same as those taught in semiautomatic rifle marksmanship, with the exception of the grip of the left hand, grip of the right hand, and the spot weld. These three steady hold factors are the same for automatic rifle marksmanship in supported and unsupported positions.

d. *Steady Hold Factors (Bipod Supported Positions).*

(1) *The left arm and grip of the left hand.* The front handgrip is grasped with the left hand and a strong pressure exerted directly to the rear, forcing the weapon against the shoulder. The handgrip is so adjusted that it cants forward about 20° from

the perpendicular to the stock) so that when the arm and wrist are straight, the sling will absorb the tension instead of the handgrip assembly, and the thumb will fit naturally against the rear of the handgrip (fig 96). Unless the firer has exceptionally long arms, no part of his left arm should touch the ground.

121 *The hinged shoulder rest and right shoulder.* The hinged shoulder rest should always be used when firing from the bipod-supported prone and foxhole positions. Position the weapon against the shoulder at the point where the neck and shoulder join so that the recoil pad is against the collar bone (fig 97), and the shoulder muscle is wedged at the junction of the hinged shoulder rest and recoil pad. The tighter the weapon is held

against the cheek, neck, and shoulder, the less dispersed will be the burst of automatic fire. Care must be taken not to buck the shoulder into the weapon while firing as it will cause the muzzle to be displaced down and to the left.

131 *The grip of the right hand.* The pistol grip is grasped so that the rear of the pistol grip rests in the "V" formed by the thumb and forefinger of the right hand (fig 98). The thumb, third, fourth, and fifth fingers close tightly around the pistol grip and exert only a slight rearward pressure. The tip of the forefinger is placed on the trigger so that there is no contact between the finger and the stock. This permits the trigger to be pressed straight to the rear without disturbing the lay of the weapon.



Figure 96. Position of left arm and grip of left hand

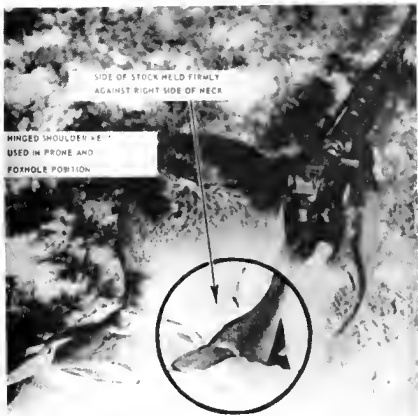

SIDE OF STOCK HELD FIRMLY
AGAINST RIGHT SIDE OF NECK

HINGED SHOULDER TEST
USED IN PRONE AND
FOXHOLE POSITION

Figure 97 Hinged shoulder test and right shoulder



Figure 98. Grip of the right hand

14) *The right elbow.* The location of the right elbow is extremely important as it provides a balance to the firing position. Position the right elbow to the side so that the right upper arm forms an angle of between 90° and 45° to the ground (fig 99). The nearer to 90° the right upper arm is held, the more stable will be the firing position. In no case should the angle be less than 45° . As a quick reference to insure correct location of the right elbow, the firer's shoulders should be checked to insure they are level and nearly parallel to the ground. It should be pointed out that failure to hold the right upper arm and shoulders in this manner is the most common error found in firing from either of the two bipod supported positions. In distributing fire to cover a linear or area target, many firers will move only the right elbow when making adjustments to the lay of the weapon. This causes the right shoulder to drop and with only this part of the body behind the weapon, dispersion of fire becomes exceptionally

wide and erratic. When lateral adjustment in the lay of the weapon requires a movement of the elbows, the entire body must be realigned directly behind the weapon.

15) *Position of the cheek (stock weld).* Because of the grip of the right hand on the pistol grip, the soldier will not have a thumb and cheek spot weld. Therefore, there is no index to insure that the cheek is placed on the stock at precisely the same point each time the weapon is lured. It should be emphasized that the cheek must be placed on the stock at the same point each time the automatic rifle is fired so that the eye will always be in the same relationship to the aperture of the rear sight. This is essential for consistent accuracy. During marksmanship training a small piece of masking tape may be placed on the stock at that point which the firer has found most suitable so that he will place his cheek at precisely that point each time he fires.

RIGHT UPPER ARM AS NEAR

TO 90° TO GROUND

AS POSSIBLE



Figure 99 Location of the right elbow

161 *Breathing* The effects of breathing in automatic rifle marksmanship are the same as in semiautomatic rifle marksmanship. In later phases of marksmanship training (transition lying), and in combat, the automatic rifleman will often be required to fire a rapid series of bursts (or single shots at long range targets). In delivering this type of fire, the automatic rifleman must learn to exhale and take a moderate breath between each burst.

171 *Muscular tension.* Contrary to the necessity for relaxation in semiautomatic lying, muscular tension of parts of the body is a necessary steady hold factor in automatic rifle firing. As stated in the explanation of the grip of the left hand, 141 above, the liver must exert a strong pressure directly to the rear on the front handgrip. This can be accomplished only by tensing the muscles of the

left arm. The steeper the pressure, all other factors being correctly applied, the less dispersed will be a burst of automatic fire. Although this muscular tension is exerted primarily by the left arm, a certain tensing of the stomach and abdominal muscles will unavoidably occur.

181 *Trigger control.* The automatic rifleman must be proficient in two types of trigger control, that used in semiautomatic fire and that used in automatic fire.

(a) *Semiautomatic fire trigger control.* Trigger control is the independent action of the forefinger on the trigger. The trigger must be brought straight to the rear with an initial pressure to take up the slack, followed by a continuous increase of pressure. The trigger finger should contact the trigger at some point between the tip

and second joint of the finger. The finger must not touch the side of the stock as this will cause pressure to be applied at a slight angle rather than straight to the rear. Such a side pressure on the rifle, no matter how slight, will tend to pull the sights off the aiming point. Correctly applied pressure on the trigger causes no movement of the rifle barrel. It also prevents the rifleman from knowing exactly when the rifle will fire, thus helping him to avoid flinching. Trigger control is the most important of the steady hold factors, and without its proper application the other marksmanship skills are practically useless. Therefore, instructors should continually emphasize this fundamental throughout automatic rifle marksmanship training.

(b) *Importance of trigger control.* Since trigger control is not only the most important steady hold factor but also the most difficult marksmanship fundamental for the inexperienced firer to master, the majority of shooting errors stem directly or indirectly from the improper application of this technique. Failure to hit the target results frequently from the firer jacking the trigger or applying pressure on both the trigger and the side of the rifle. Either of the actions can produce misses.

(c) *Automatic fire trigger control.* Correct trigger control in automatic fire has an additional purpose. The number of rounds in a burst is governed by manipulation of the trigger. Throughout automatic rifle marksmanship training, emphasis must be placed on the use of three-round bursts. To fire a three-round burst, the soldier must press the trigger to the rear and immediately release it.

83. Positions

a. In automatic fire, positions are an important aspect of marksmanship. To better understand this, let us assume that the firer has a good zero, aims his weapon correctly, and properly applies all of the steady hold factors in firing a burst of three rounds. The first round of that burst will hit the target at the point of aim, but this will not necessarily be true of the second and third rounds. The first round hits the aiming point the same as when a round is fired singly; however, the recoil from the first and subsequent rounds will disturb the lay of the weapon progressively with each round of the burst.

The relationship between the point of impact of the first and subsequent rounds of the burst will depend to a very great degree on the stability of the firer's position. The firer's body, directly behind the weapon, serves as a foundation, and his grip serves as a lock to hold the weapon against this foundation. The better the body alignment and the steadier the grip, the less dispersed will be the rounds of a burst of automatic fire.

b. There are three positions which provide the most accurate means of delivering automatic fire with the M14A1 and the M14 (modified). The three positions are the underarm firing position, the hipod supported prone position, and the hipod supported foxhole position.

Note. If the tactical situation necessitates firing from the standing, kneeling, or kneeling supported firing position the semiautomatic fire will provide the best results.

(1) *Underarm firing position.* This position (fig 100) is used in those situations where the automatic rifleman is required to move short distances when contact with the enemy is imminent, or to engage close-in, fleeting targets. By placing the right forearm along the stock, the rifleman is able to exercise greater control over the automatic rifle. This position is assumed in the following manner:

(a) With the right forearm, place and hold the rear portion of the stock against the body at a point between the waist and the armpit.

(b) It is unnecessary to use a sling; however, the sling may be used to support the automatic rifle, reduce firer fatigue in carrying the weapon, and allow the left hand maximum freedom for occasional changes. The sling is placed over the right shoulder. The use of the right shoulder to support the automatic rifle in this position gives the firer optimum flexibility in reacting to tactical conditions because he is not unduly restricted by the sling. The muscle end of the sling rises on the outside of the stock and barrel; the butt end of the sling rises on the inside of the stock.

(c) To attain the best balance when firing, the left foot should be well forward of the right. When the firer must continue to move while firing (as in the assault), he attempts to fire bursts in a rhythmic manner. He bends at the knees and leans forward as in a boxer's crouch.



Figure 100 Underarm firing position with the M1441 rifle

(2) *Bipod supported prone position.* The bipod supported prone position is the most stable position from which to fire the automatic rifle, and it should be used whenever the tactical situation permits (Fig 101). This position has the advantage of presenting a low silhouette and is easily adapted to the use of cover and concealment. Its primary disadvantage is the limitation of its use in heavily vegetated or irregular terrain where the firer's field of view may be limited.

(a) The bipod supported prone position is assumed as follows:

1 The firer stands facing the target with his feet spread a comfortable distance apart while holding the weapon with the left hand at the balancer, the right hand at the pistol grip.

2 He drops to his knees and removes his right hand from the pistol grip, falls forward breaking his fall with the right hand well forward of and on line with the right knee.

3. He extends his left arm forward, places the weapon on the ground and lowers his body to the ground on the left side and elbow.

4. With his right hand, he raises the hinged shoulder rest. He grasps the small of the stock with his left hand and places the weapon into his shoulder.

5. With his right hand, he grasps the

pistol grip. The firer lowers his right elbow and grasps the front handgrip with the left hand.

(b) The following points should be checked on this position:

1. The body should be aligned so that if an imaginary straight line were drawn through the barrel and receiver, it would pass over the firer's right shoulder and through the center of his right buttock.



Figure 101. Bipod supported prone position with the M141 rifle

2. The legs should be spread well apart with the toes pointing outward and, if the conformation of the body permits, the heels should be on the ground.

3. The back should be arched, the chest off the ground and the shoulders parallel to the ground.

4. The left arm and wrist should be straight, with no part of the arm touching the ground.

5. The right upperarm should form an angle as near to 90 degrees to the side as the conformation of the firer's body will permit.

131 *Bipod supported foxhole position.* The bipod supported foxhole position (fig 102) is primarily a defensive position. It is also used in

offensive operations where the automatic rifleman is required to fire from high cover, e.g., deep ditches, chest-deep ravines, shell craters, and high road bands.

(a) The bipod supported foxhole position is assumed as follows:

1. The rifleman places the bipod legs on the elbow rest. (This may require moving the parapet or sandbag cover forward.)

2. He leans forward until his chest is squarely against the forward wall of the hole.

3. He raises the hinged shoulder rest and places the butt of the rifle into the shoulder. He raises his head, places the stock firmly against the neck with the right hand, lowers his head, and places the cheek naturally against the stock.

4. He extends his left arm over the forward edge of the hole and grasps the front handgrip with the left hand. The left arm and wrist should be straight. He exerts a strong rearward pressure on the front handgrip.

5. He then places his right elbow on solid support inside the parapet so that the right forearm forms an angle of 90 degrees to 45 degrees to the side. The weapon should not rest on, or touch, any support other than the bipod.

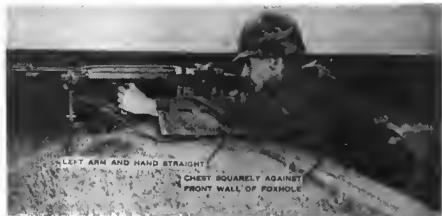

Figure 102. Bipod supported in-hole position with the M14A1 rifle.

(b) The hollowing points should be checked in this position.

1. The shoulders should be parallel to the ground.

2. The grip of the right and left hands should be identical to that used in the bipod supported prone position.

3. The left arm and wrist should be straight. The right upper arm should be as near to 90° degree to the side as the conformation of the firer's body will permit.

84. Integrated use of Automatic Rifle Shooting, M14 (Modified)

a. *Aiming*. See paragraph 82 a.

b. *Steady Hold Factors*. Application of the steady hold factors with the M14 (modified) differs from that with the M14A1. This is due primarily to weapon design.

(1) *Steady hold factors (unsupported positions)*. When firing from the kneeling, kneeling supported (without bipod), and standing positions, semiautomatic fire should be employed. The steady hold factors, affecting weapon stability in these positions, are identical to those described in paragraph 38 b.

(2) *Steady hold factors (bipod supported positions)*. The eight steady hold factors affecting

weapon stability when employing the M14 (modified) in the bipod supported prone or in-hole positions are:

(a) *Grip of the left hand*. The firer initially forms a loop in the sling by sliding the keeper forward to a point approximately 3 inches from the upper sling swivel. He then inserts the fingers of the left hand into the loop (the thumb on the outside), forms a clenched fist, and applies constant pressure downward and rearward. The firer's left arm should be straight and should not come in contact with the ground (fig. 104, 105); however, the firer's body conformation may necessitate modifying the position of the left arm. Altering the position of the left arm is acceptable as long as the firer is able to maintain a constant firm downward and rearward pressure.

(b) *The hinged shoulder rest and right shoulder*. See paragraph 82 d (2).

(c) *The grip of the right hand*. Place the right hand at the small of the stock with the thumb over the small of the stock. The forefinger (any part of the finger from the tip of the second joint) is placed on the trigger. The trigger finger should not touch the side of the stock. The remaining fingers of the right hand are curled around the small of the stock. With the right hand, pull the weapon firmly into the shoulder.

(d) *Right elbow.* As previously mentioned, the right elbow aids in forming a pocket in the right shoulder and in stabilizing the position. The firer's shoulders should be level (para §2 d14).

(e) *Position of the cheek (spot weld).* The position of the cheek (spot weld) is the point of firm contact between the firer's cheek and thumb on the small of the stock. It is obtained by lowering the cheek to the thumb, which is curled over the small of the stock, and rolling up a pad of flesh against the cheekbone to act as a buffer. The spot weld enables the firer's eye to be positioned the same distance behind the rear sight aperture each time the rifle is aimed and fired. This causes the diameter of the rear sight aperture to appear the same each time a sight picture is obtained, thus further assisting in maintaining correct sight alignment. If the soldier is unable to obtain a spot weld, he should use a streak weld by placing his cheek directly against the stock. The streak weld, if properly used, will achieve the same results as will the spot weld.

(f) *Breathing.* See paragraph 35 b16).

(g) *Muscular tension.* See paragraph 82 d17).

(h) *Trigger control.* See paragraph 82 d18).

c. *Firing Positions.*

(1) *Prefiring checks.* The automatic riflemen must make five prefiring checks on the M14 (modified) before firing. These checks are as follows:

(a) *Selector.* The selector is checked to insure it is set for the desired type of fire.

(b) *Sling.* The sling is loosened and made free of the trigger and magazine well and the keeper adjusted by sliding it forward to a point approximately 5 inches from the upper sling swivel to form a loop in the sling.

(c) *Spindle valve.* The spindle valve is checked to insure that the slot is perpendicular to the barrel.

(d) *Gas cylinder plug.* The gas cylinder plug is tightened with the combination tool. Should it become loose, the rifle will fire sluggishly or fail to fire.

121 *The unsupported underarm firing position* (fig 103). The underarm position is designed primarily for use in the assault and for engaging close in, fleeting targets; however, it can be used in any situation which requires the soldier to fire while moving. This position is assumed as follows:

(a) Face the target with the feet spread approximately shoulder width apart.

(b) Place the left foot in front of the right (use 30-inch step) with most of the weight on the lead foot.

(c) Slightly bend both legs at the knees and lean forward at the waist as in a boxer's crouch.

(d) With the right hand, grasp the small of the stock and with the forearm, hold the stock firmly against the side of the body at a point between the armpit and the waist.

(e) With the left hand, grasp the rifle firmly as a point just short of the front sling swivel. The thumb and fingers should not be placed over the handguard as it becomes extremely hot after firing several magazines automatically.

(f) Depress the muzzle of the rifle slightly so you can observe the strike of the rounds, thus avoiding overshooting and taking advantage of ricochets.

(3) *Biped supported prone position* (fig 104). The biped supported prone position with the M14 rifle (modified) is the same as with the M14A1 except for the use of the sling as outlined in b above. The proper method of assuming the biped supported prone position is the same as outlined in paragraph 83 h. Particular attention should be focused on the following points to insure that the firer has assumed the correct position.



Figure 103 Underarm firing position with M14 rifle (modified)



Figure 104 Bipod supported prone position with the M14 rifle (modified).

(a) The body should be aligned so that the axis of the rifle, if extended to the rear, would intersect the firer's shoulder and the center of his right buttock.

(b) The legs should be spread well apart with the toes pointing outward, and if the conformation of the body permits, the heels should be on the ground.

(c) The back should be slightly arched with the firer's chest off the ground and the shoulders parallel to the ground.

(d) The left arm should be straight, exerting a downward, rearward pressure and should not be touching the ground.

(e) The right upper arm should form an angle of 90 degrees with the ground, so far as the conformation of the firer's body will permit.

(4) *Bipod supported foxhole position* (fig 105). The bipod supported foxhole position with the M14 rifle (modified) is the same as the bipod supported foxhole position with the M14A1 rifle,

except the position of the hands are as explained in paragraph 84 b.

85. Night Firing Positions

a. *Mode of Fire.* When engaging targets during periods of limited visibility, the best mode of fire is automatic fire in three round bursts.

b. *Firing Position.* The recommended firing position for use during periods of limited visibility is the bipod supported prone position with a slight modification (fig 119). During periods of limited visibility, the firer cannot use his sights. Therefore, to effectively engage targets during periods of limited visibility, the firer assumes the bipod supported prone position, establishes a raised-stock weld (looks 2 to 3 inches above the sights on a level plane with the barrel), points the weapon at the target, and fires three-round bursts. The firer should keep both eyes open and his head, arms, and rifle should move as one unit.



Figure 105 Bipod supported foxhole position with the M14 rifle (modified).

86. Automatic Fire

a. Automatic fire is the firing of two or more consecutive rounds without releasing the trigger. Bursts of three rounds are usually fired to insure minimum dispersion. When does the automatic rifleman employ his weapon in the automatic role, and when does he employ it in the semiautomatic role? To answer this question, the automatic rifleman must first understand the nature of automatic fire, its advantages and limitations, and the contrasts between automatic and semiautomatic fire. Only through such an understanding will the automatic rifleman know how and when to most effectively employ his weapon in any given situation.

(1) *Semiautomatic fire.* Semiautomatic fire is employed where the range to the target is in excess of 460 meters, and in any situation where a high degree of accuracy is required to hit a small point target, e.g., blanked apertures, windows, and single enemy personnel.

(2) *Automatic fire.* Automatic fire is employed:

(a) When engaging enemy formations at ranges to 460 meters.

(b) When engaging large point targets such as crew-served weapon emplacements, unarmored vehicles, and openings in buildings to ranges of 460 meters.

(c) To attain fire superiority when warranted by the tactical situation.

b. As pointed out in the explanation of the importance of position stability, automatic fire will not be as accurate, per round fired, as

semiautomatic fire. This decreased accuracy must be compensated for by the delivery of a heavy volume of fire. A heavy volume of fire is attained in machinegun fire where ammunition is belt-fed and requires no interruption of fire for reloading. However, with a magazine-fed automatic rifle the volume of fire is governed by the automatic rifleman's ability to load and change magazines. Sustained automatic rifle fire is limited by the 20-round magazine. To attain a heavy volume of fire, the automatic rifleman must be able to change the magazine in 4 to 5 seconds. This level of proficiency can only be attained through thorough and intensive training in the fundamentals of automatic fire.

87. Magazine Handling

a. Magazine Carrying

(1) The automatic rifleman is taught that the time loss in changing magazines can be minimized by placing his magazines in the ammunition pouches in the proper manner. The following procedures should be followed:

(a) Two magazines are placed in each ammunition pouch with the open end down, the long edge to the rear (fig 106). This provides a systematic method for removing the magazines.

(b) To remove a magazine from the pouch, grasp the magazine with the thumb between the magazine and body with the remaining fingers on the outside of the magazine. While withdrawing the magazine from the pouch, extend the arm to the front, rotate the hand and magazine 180° causing the open end of the magazine to face the feed well.

(c) Right-handed firees are taught always to

use the magazines on the right side of the body first. Empty magazines must be saved for reloading and later use. A field expedient method of carrying

expended magazines is to attach an empty sandbag to the load-bearing equipment.



Figure 106 Proper method of carrying magazines

b. Magazine Changing

(1) *Right-side load.* To load a magazine from the right side, the automatic rifleman uses his right hand. He removes the empty magazine from the weapon, secures and loads the next magazine into the weapon, and then releases the operating rod handle. The left hand should never be taken away from the weapon during the right side load.

(2) *Left-side load.* To load a magazine from the left side, the automatic rifleman uses his left hand. He removes the empty magazine from the weapon, secures and loads the next magazine into the weapon, and then reaches up and over the receiver to release the operating rod handle. The right hand should never be taken away from the weapon during the left-side load.

88. Fire Distribution

a. General. The automatic rifleman must be trained to deliver fire at targets which have one or

more selected aiming points. When fire is delivered at one aiming point, it is called concentrated fire; when it is delivered at more than one aiming point, it is called distributed fire.

b. Concentrated Fire. Concentrated fire is fire directed at a specific point which requires a high degree of accuracy. Rifle marksmanship training has taught the soldier to think principally in terms of concentrated fire; he must now be taught to apply the integrated act of automatic rifle shooting in distribute, as well as to concentrate, his fire.

c. Distributed Fire. Distributed fire is fire in depth and width so that a target is effectively covered. The object of distributed fire is to place a heavy volume of fire between the known or suspected flanks of a target. The automatic rifleman must attempt to place fire within the area of such a target. It should be strongly emphasized that the inability to see enemy personnel or

positions should not be a reason for not firing into an area if there is reason to suspect the presence of a covered or concealed target. Effective fire distribution is attained by correct application of the eight steady hold factors and correct body position. Body alignment and the position of the shoulders and right elbow become an area of major concern in distributing fire. Incorrect body alignment and the position of the shoulders and the right elbow will cause erratic dispersion of fire. Where only small adjustments to the lay of the weapon are required the automatic rifleman moves only his shoulders to the right or to the left. He must insure that the right elbow remains in place and that the shoulders remain parallel to the ground. If the lateral adjustment required is enough to require a movement of the elbows, the automatic rifleman must re-lay his weapon by shifting his entire body so that the shoulders are level and correct body alignment is maintained. When delivering automatic distributed fire, the first round of each burst is aimed. The automatic rifleman selects successive aiming points

across the target and fires back and forth across the target in three round bursts until either fire superiority has been gained or the target has been neutralized.

89. Conduct of Training

a. *Twenty-Five Meter Automatic Firing.*

11) *General.* Initial live fire training is conducted on the standard 25-meter range. The standard automatic fire target (FSN 6920-657-9361) (fig 107) is the only target required to conduct 25-meter preparatory marksmanship training. Twenty-five meter firing is designed to develop proficiency in each of the fundamentals of automatic rifle marksmanship, prior to engaging targets under simulated combat conditions on the standard automatic rifle range / field fire range modified for automatic fire. This practical exercise is not scored.

12) *Conduct of fire.* Twenty-five meter firing is conducted in three phases.

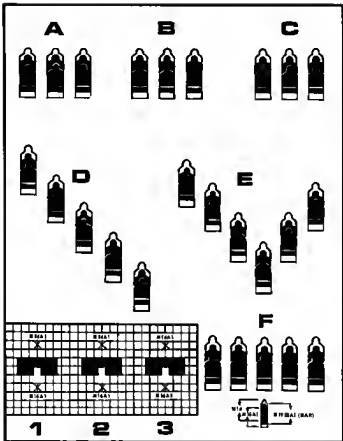

Figure 107. Standard 25-meter automatic rifle target.

(a) Fire two three-round magazines using a three-round burst at one of the zero targets (in the lower left hand portion of the standard 25-meter automatic fire target).

(b) Fire two six-round magazines using three-round bursts at configuration "B" and "C" on the standard 25-meter automatic fire target.

(c) Fire one 18-round magazine using three-round bursts at configuration "E" on the standard 25-meter automatic fire target.

b. Automatic Transition Firing.

11) *General.* The ultimate objective of automatic transition firing is to produce combat

proficient automatic riflemen—not to award qualification badges. Automatic transition firing consists of a series of practical live fire exercises which require the soldier to apply all of the fundamentals of automatic rifle marksmanship learned in preparatory marksmanship training. When automatic transition firing is correctly organized and conducted, the soldier will gain valuable experience toward becoming a proficient combat automatic rifleman, regardless of his qualification rating. Properly used, qualification ratings are important in motivating the soldier and providing the commander with an aid in identifying the more

proficient automatic riflemen of his unit. This can be a significant consideration in the commander's assignment of personnel as the better marksmen should be assigned evenly throughout all elements of a combat unit.

(2) *Training concepts.* The most significant advantage afforded by the automatic transition course of fire is that it requires the automatic rifleman to fire at the types of targets he would be expected to engage in combat. It is on a standard automatic rifle range that the automatic rifleman demonstrates his proficiency in automatic rifle marksmanship. The soldier applies the fundamentals of delivering fire using two methods: concentrated fire against point targets and distributed fire against linear or area targets.

(3) *Range facilities.*

(a) The standard automatic rifle range (fig 108) consists of a minimum of ten firing lanes. Each lane is 5 to 10 meters wide at the firing line and 75 meters wide at a range of 600 meters. Odd numbered lanes (1, 3, 5 etc.) are designated A and the even numbered lanes (2, 4, 6 etc.) are designated B. A foxhole is constructed on each B lane. Target devices are installed at ranges from 100 to 400 meters. Four different target configurations are presented to the automatic rifleman during the conduct of transition firing: the small area, the large area, the linear, and the single F-type silhouette. Target configurations are shown in figures 109, 110, and 111. For efficient operation

and scoring the target holding mechanisms M30/M31A1 are used. The score for each target exposure is determined by the number of targets downed after each exposure except for the small area target (fig 109) for which only one point is awarded.

(b) When constructing a range or modifying an existing facility, the terrain should be left primarily in its natural state. Targets should be emplaced making the best use of available concealment and still be reasonably consistent with the ability of soldiers to detect targets during the conduct of firing. Where manually operated targets are used, inconspicuous bunkers should be constructed.

(c) Each lane will have a target control point approximately 20 meters to the rear of the firing line behind each firing point. This control point is required to control the raising and lowering of targets at the proper time and to facilitate scoring.

(d) If an acceptable standard automatic rifle range is not available, firing may be conducted on a field fire range that has been modified for automatic fire (fig 112). For exposure times, sequences, and range to exposed targets reference the alternate automatic rifle scorecard figure 114. Each firing order fires sequence "A" from the bipod supported fanhole position and then sequence "B" from the bipod supported prone position.

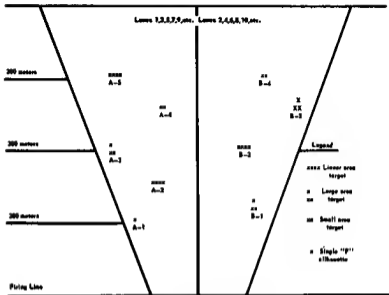

Figure 108. Standard automatic rifle range.

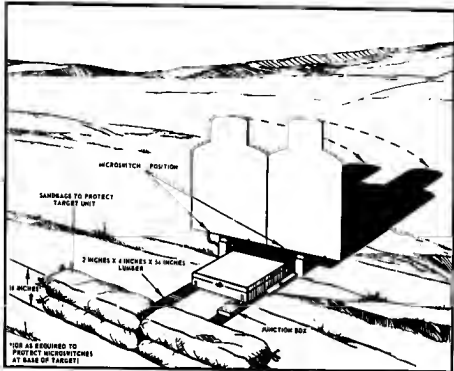

Figure 109. Small area target, standard automatic rifle range.

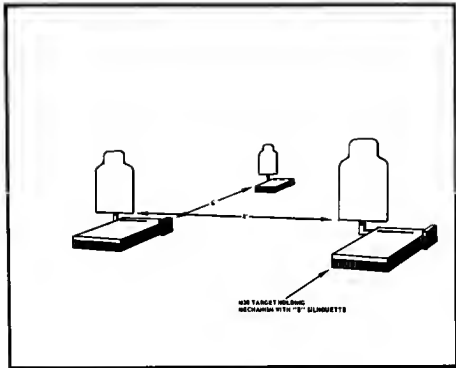

Figure 110. Large area target, standard automatic rifle range.

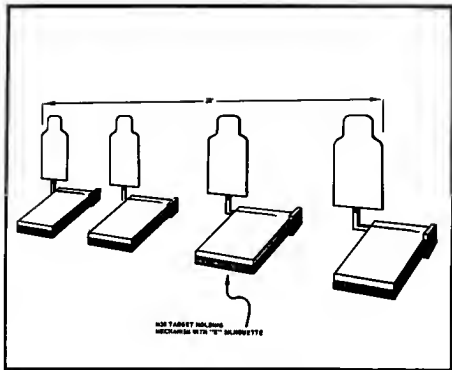
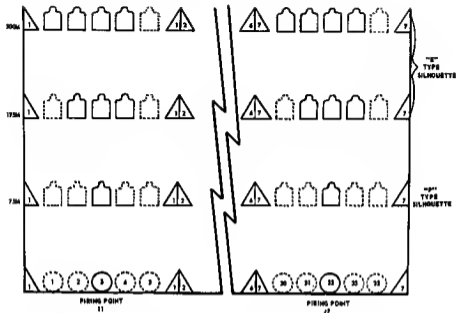

Figure 111. Linear target, standard automatic rifle range.



TYPE
TGT

LEGEND:

- 4 — LINEAR AREA TARGET 300 METERS
- 8 — SMALL LINEAR TARGET 175 METERS
- 3 — LINEAR/POINT TARGET 175 METERS/75 METERS
- 1 — POINT TARGET 75 METERS

NOTE:

- REMOVE FROM
MOUNT TARGET HOLDING MECHANISMS
- POXHOLES ROW USED
- LANE MARKERS

Figure 112. Rifle marksmanship field fire range (modified for automatic rifle transition firing).

(4) *Range personnel.* The following personnel are required in addition to those listed in paragraph 63.

(a) *Scorer-target operator.* One scorer is assigned to each lane. Upon receiving the firer's scorecard, the scorer will insure its heading has been filled out correctly. He is responsible for controlling the targets (to include time exposure) and recording hit data for his lane.

(b) *Lane noncommissioned officer.* One lane NCO is assigned to each firing lane. His duty is to insure that safety regulations are complied with. The lane NCO will point out the left and right limits of the firer's lane, issue ammunition to the firer, and rule on the validity of claims.

c. *Qualification firing.* At the completion of automatic transition firing the soldier's proficiency is tested by firing a qualification course of fire. The qualification course of fire is conducted on the same

range as the transition firing. Exposure times, sequence, and range to the targets are outlined in figure 113 (standard automatic scorecard) and figure 114 (alternate automatic scorecard).

11. Automatic rifle qualification scores (hits and ratings) are as follows:

Rating	Number of hits
Expert	27-32
Sharpshooter	23-26
Marksmen	16-22
Unqualified	15 and below

12. Those soldiers who fail to meet the minimum standard of 16 may refire the qualification course. In all cases where a re-fire is required to obtain the minimum score, the maximum rating will be marksmen and the maximum score will be 16.

SCORECARD - AUTOMATIC RIFLE						
STANDARD AUTOMATIC RIFLE TRANSITION FIRING						
For use of this form, see A3055ed 23-72 and FM 23-7; the proponent agency is the US Army Training and Doctrine Command.						
Last Name - First Name - Middle Initial			Class	Date		
DNE JOHN R			A-1-31	25 JUL 73		
Grade		SSN	Order No.			
E-2		576-96-6948	1			
PERIOD I						
Line (1)	Target No. (2)	Range (Meters) (3)	Rounds Fired (4)	Exposure Time (Sec) (5)	HAS TEST KILLS (6)	SCORE TEST KILLS (7)
A	1	100	3	10	1	1
A	2	150	3	10	1	1
A	3	200	3	10	1	1
A	4	250	3	11	1	1
A	5	300	3	12	1	1
A	6	350	3	13	1	1
Total Line A					6	6
Total Line B					6	6
Grand Total					12	12
PERIOD II						
Line (1)	Target No. (2)	Range (Meters) (3)	Rounds Fired (4)	Exposure Time (Sec) (5)	HAS TEST KILLS (6)	SCORE TEST KILLS (7)
A	1	100	3	10	1	1
A	2	150	3	10	1	1
A	3	200	3	10	1	1
A	4	250	3	11	1	1
A	5	300	3	12	1	1
A	6	350	3	13	1	1
Total Line A					6	6
Total Line B					6	6
Grand Total					12	12

DA FORM 3085-R, 1 Nov 73

REPLACES DA FORM 3085-R, 1 JUN 69, AND TOGETHER WITH DA FORM 3085-R, 1 NOV 73, REPLACES DA FORM 3085-R, 1 SEP 71, WHICH ARE OBSOLETE.

1 Foot

Figure 113. Sample of standard automatic rifle transition firing scorecard, with entries DA Form 3085-R.

PERIOD 19		30 PRACTICE				
LAHR (1)	TARGET NO. (2)	RANGE (METERS) (3)	ROUNDS FIRED (4)	EXPOSURE TIME (SEC) (5)	MAX TGT KILLS (6)	SCORE (TGT KILLS) (7)
A	1	200	3	15	1	1
A	5	200	12	60	4	4
A	3	200	9	30	3	3
A	4	200	3	15	1	1
A	2	150	10	60	4	4
A	5	200	9	30	3	3
TOTAL LAHR A					16	11
R	1	125	9	30	3	2
B	3	200	12	60	4	4
R	5	200	8	30	3	2
B	4	200	5	15	1	1
B	2	200	12	60	4	4
B	4	200	3	15	1	1
TOTAL LAHR B					16	11
GRAND TOTAL					32	22
PERIOD 20		QUALIFICATION FIRING				
LAHR (1)	TYPE (2)	RANGE (METERS) (3)	ROUNDS FIRED (4)	EXPOSURE TIME (SEC) (5)	MAX TGT KILLS (6)	SCORE (TGT KILLS) (7)
A	3	200	9	45	5	3
A	1	200	3	15	1	1
A	5	200	12	60	4	4
A	4	200	3	15	1	1
A	2	150	12	60	4	4
A	3	200	1	45	2	2
TOTAL LAHR A					16	15
B	3	200	12	60	4	4
B	1	125	1	45	3	2
B	4	200	3	15	1	1
B	3	150	1	45	1	1
B	4	200	3	15	1	1
B	3	200	12	60	4	4
TOTAL LAHR B					14	14
GRAND TOTAL					30	29
SIGNATURE OF SCORER		<u>John Black</u>				
		QUALIFICATION RATINGS (CIRCLE ONE) (TOTAL HITS)				
EXPERT ----- 27 - 32		MARKSMAN ----- 16 - 26				
SHARPSHOOTER --- 23 - 26		UNQUALIFIED ----- 13 AND BELOW				
SIGNATURE OF SCORER		<u>Joe Smith 1st Sgt</u>				

2 Back
Figure 113—Continued.

SCORECARD - AUTOMATIC RIFLE

ALTERNATE AUTOMATIC RIFLE TRANSITION FIRING

(MODIFIED FIELD FIRE RANGE)

For use of this form, see ASub(Sod 23-72 and FM 23-9; the proponent agency is the US Army Training and Doctrine Command.

LAST NAME - FIRST NAME - MIDDLE INITIAL			UNIT	DATE		
DRE JOHN R			A-1-31	25 JUL 75		
GRADE	SSN	ORDER NO.	FIRING POINT			
E-2	576-94-6943	1	7			
PERIOD 17 SEQUENCE A						
POSITION	TYPE TARGET*	RANGE (M)	RDS FIRED	EXPOSURE TIME (SEC)	MAX TGT KILLS	SCORE (TGT KILLS)
FOX HOLE BIPOD SUPPORTED	1	75	3	15	1	1
"	2	175	6	45	3	2
"	2	175	9	45	3	2
"	2	75	3	15	3	1
"	2	175	3	45	3	1
"	1	75	3	15	1	1
SUB-TOTAL					12	8
SEQUENCE B						
PRONE BIPOD SUPPORTED	2	175	9	45	3	2
"	2	75/175	12	60	4	2
"	1	75	3	15	4	1
"	3	75/175	12	60	4	3
"	2	75/175	12	60	3	2
"	4	300	12	60	3	3
SUB TOTAL					29	13
GRAND TOTAL					35	21
PERIOD 18 SEQUENCE A						
POSITION	TYPE TARGET*	RANGE (M)	RDS FIRED	EXPOSURE TIME (SEC)	MAX TGT KILLS	SCORE (TGT KILLS)
FOX HOLE BIPOD SUPPORTED	1	75	3	15	1	1
"	4	300	12	60	4	2
"	2	175	9	45	3	2
"	1	75	3	15	1	1
"	3	75/175	12	60	4	2
"	2	175	9	45	3	1
SUB-TOTAL					16	9
SEQUENCE B						
PRONE BIPOD SUPPORTED	1	75	3	15	1	1
"	4	300	12	60	4	1
"	2	175	9	45	3	3
"	2	175	9	45	3	3
"	4	300	12	60	4	2
"	1	75	3	15	1	1
SUB TOTAL					16	11
GRAND TOTAL					35	20

DA FORM 3008-R, 1 Nov 73

REPLACES DA FORM 3008, 1 JUN 62 AND 708572EN
 WITH DA FORM 3008-R, 1 NOV 73, REPLACES DA FORM
 3001-R, 1 FEB 71, WHICH ARE OBSOLETE.

1 Front

Figure 114. Sample of alternate automatic rifle transition firing scorecard, with entries DA Form 3008-R.

PERIOD 19		SEQUENCE A				
POSITION	TYPE TARGET*	RANGE (M)	RDS FIRED	EXPOSURE TIME (SEC)	MAX TGT KILLS	SCORE (TGT KILLS)
FOXHOLE BIPOD SUPPORTED	1	75	3	15	1	1
//	4	300	12	60	4	3
//	2	175	9	45	3	1
//	1	75	3	15	1	1
//	4	75/175	12	60	4	2
//	3	175	9	45	3	3
SUB-TOTAL					16	11

SEQUENCE B						
POSITION	TYPE TARGET*	RANGE (M)	RDS FIRED	EXPOSURE TIME (SEC)	MAX TGT KILLS	SCORE (TGT KILLS)
PRONE BIPOD SUPPORTED	1	75	3	15	1	1
//	2	300	12	60	4	4
//	2	175	9	45	3	2
//	4	175	9	45	3	1
//	4	300	12	60	3	1
//	4	75	3	15	1	1
SUB TOTAL					16	11
GRAND TOTAL					32	22

PERIOD 20		SEQUENCE A QUALIFICATION FIRING				
POSITION	TYPE TARGET*	RANGE (M)	RDS FIRED	EXPOSURE TIME (SEC)	MAX TGT KILLS	SCORE (TGT KILLS)
FOXHOLE BIPOD SUPPORTED	2	175	3	45	3	3
//	1	75	3	15	1	1
//	3	75/175	12	60	4	3
//	1	75	3	15	1	1
//	1	300	12	60	3	3
//	1	175	9	45	3	2
SUB TOTAL					16	13

PRONE BIPOD SUPPORTED	3	75/175	12	60	4	3
//	2	175	9	45	3	2
//	1	75	3	15	1	1
//	2	175	9	45	3	2
//	1	75	3	15	1	1
//	4	300	12	60	4	3
SUB TOTAL					16	13
GRAND TOTAL					32	26

*SEE RANGE DIAGRAM FOR TARGET CONFIGURATION- (FIG. 5)

SIGNATURE OF SCORER Tom Black

QUALIFICATION RATINGS (CIRCLE ONE) (TOTAL HITS)

EXPERT ----- 27 - 32

SHARPSHOOTER ----- 23 - 26

MARKSMAN ----- 16 - 22

UNQUALIFIED ----- 15 AND BELOW

SIGNATURE OF OFFICER Joe Smith 1st Inf.

(3) Basic trainees who fail to meet the minimum standard of 16 will receive remedial training and re-fire. If they still do not meet the minimum standard, they will be recycled or if the

individual case warrants, a weapons qualification waiver will be requested in accordance with applicable regulations.

CHAPTER 8

QUICK FIRE

Section I. GENERAL

90. Purpose

This chapter provides guidance in training procedures and techniques for instruction of the fast, unaimed method of fire called *quick fire*.

91. Background

a. Quick fire, a military development of a technique called *instinct shooting*, is simply doing what comes naturally. It is a distinct departure

from most methods taught, which tend toward mathematical precision. The key to the successful employment of this technique is **simplicity. IT IS AS SIMPLE AS POINTING THE FINGER.**

b. When time allows it is always preferable to use a well aimed shot; however, when the occasion calls for a quick reflex action as a prerequisite to survival, there is no substitute for a ready and working knowledge of quick fire.

Section II. QUICK FIRE WITH THE M14 RIFLE

92. Training Technique

a. Although the effective quick fire shooter does not consciously aim his rifle barrel when picking up his target, he must be able to relate himself to it; e. g., the driver of an automobile keeps it on the road by looking to the horizon (to maintain his position on the road) and at the hood of the car (as it appears in his peripheral vision), relating the car to the road. Practice firing with the *sights taped* will reduce the tendency to aim with the sights, and at

the same time assist the firer in obtaining the relationship between the rifle and target (fig 1151).

b. To assume the proper position for engaging targets, the firer leans slightly forward, holds the weapon at the low port position, spreads his feet a comfortable distance apart, and balances his weight on the balls of his feet so that he can engage targets within an arc of 120° to his front without having to shift his feet.



Figure 115. Side and rear views of rifle showing sights taped

c. The firer must look at the base of the target. The reason for this is that it is a natural tendency to shoot over targets because of overestimating distances and an urge to draw a comparison between the barrel and the target. Also, if the firer does miss, he wants his shot to be low so that there still remains the possibility of effectively engaging his target with a ricochet.

d. Firer should make a slight "jabbing" motion at his target as he brings the weapon to his shoulder and stock to his jaw. He should not swing into firing position.

e. While the weapon is being shouldered, and

during the firing, the firer's eyes (BOTH EYES OPEN) MUST be riveted on the contrasting colored spot in the lower third of the target (Fig 116). In order for him to do this, he MUST drop the weapon from his line of sight so that he makes no comparison between the target and the muzzle.

f. The firer is now ready to shoot. Should he miss a target, he is to engage a different one rather than continuing to fire on the missed silhouette because the firer sees the strike of his bullet. In the case of a miss he will be inclined to bracket or shoot right back where he made his original error if he does not shift targets and erase the incorrect visual picture from his mind.

Note. Emphasize, however, that a firer would not shift targets in combat should he miss, but would continue in his efforts to effectively engage the same enemy target. The shifting from a missed ground silhouette to another is merely a training aid to assist him in developing skill until he becomes proficient and instinctive in his reaction.

g. The firer is "on target" as soon as his weapon is locked into position and he should not hesitate to fire. The longer he waits, the more he is apt to miss or attempt to draw a comparison between the target and the muzzle. On the other hand, he should not hurry his shot. He should shoulder the weapon in one smooth fluid movement, not hurriedly jerk it to his shoulder. Haste actually slows him down and makes his shooting erratic.

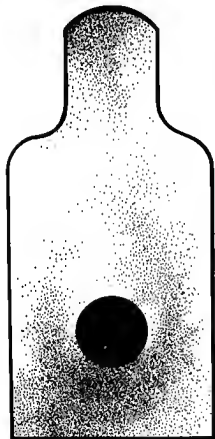

Figure 116. Front view of E-type silhouette illustrating painted circle as focal point for soldier who will engage it.

93. M14 Quick Fire Field Firing

a. The soldier initially engages the E-type silhouette as pictured in figure 109 using the M14 with taped sights at a range of 15 meters. This silhouette should have a circle 5- to 7.5-cm (2 to 3 inches) in diameter painted in the center of the lower third to afford the firer a definite spot on which to focus his vision.

b. Once the firer is 80 percent proficient in hitting the E-type silhouette at 15 meters, the firing line is moved back to 30 meters and the firer again engages this E-type silhouette.

Note. No useful purpose is served in extending the firer's range until he is effective at 15 meters.

c. After the firer is effective at engaging the E-type silhouettes at 30 meters, the tape should be removed from the front and rear sights. With tape removed the firer again engages the E-type silhouette at both ranges. Assistant instructors should observe each firer to insure that he is not aiming the weapon. If the firer attempts to aim, the tape should be put back on the sights.

CHAPTER 9

RECORD FIRE

Section I. GENERAL

94. Purpose

Record firing is a series of practical exercises which require the soldier to apply individual rifle marksmanship techniques learned in previous instruction. Although the soldier receives a qualification rating based on the number of targets he hits, record firing should not be considered so much a test as it is an extremely valuable training exercise. When record firing is correctly organized and conducted, any soldier can gain valuable experience and become more effective as a combat rifleman regardless of his qualification rating. Properly used, qualification ratings are important, since they provide goals for the individual soldier. They also aid the commander in identifying the more proficient marksmen in his unit. This can be a significant consideration in the assignment of personnel, since the better marksmen should be evenly distributed among all elements of a combat unit. However, the ultimate objective of record firing, like all combat marksmanship training, is to produce uniform proficient marksmen—not to award qualification ratings.

Section II. RECORD FIRE—DAYTIME

96. General

The standard record firing range achieves realism by presenting the firer with various target situations he will likely encounter in combat. Except where modification is necessary to install and maintain targets, the terrain is left undisturbed. Upon completion of record firing the number of targets hit by each firer is totaled. Based on this score, marksmanship qualification ratings are awarded. The qualification rating is based upon the collective scores at Record Fire f, Record Fire ff, and Night Record Fire.

97. Organization

a. *Firers.* For scheduling purposes the average company of approximately 200 men must be divided in half. While half of the unit is firing the record course, the other half of the unit receives other training as prescribed by the commander. Since only half of a unit can be scheduled at one

98. Training Concepts

a. *Uniform and Equipment.* While firing the record course, soldiers should not be required to wear equipment. Tests have proven that the results will be the same whether they wear it or not.

b. *Assistance to Firers.*

(1) Record firing is strictly an individual effort of each soldier. The firer should not receive coaching or any other assistance during the exercise. This is particularly true of detecting targets, determining ranges, and locating the impact of bullets. If a rifle sustains a malfunction, it is the firer's responsibility to apply immediate action and attempt to eliminate the stoppage.

(2) The single exception to not assisting the firer is in the interest of safety. A firer attempting to clear a stoppage may inadvertently point the muzzle of his rifle to the flanks or rear. In such instances, the scorer or other range personnel should immediately correct the unsafe condition. During exercises in which the firer is moving, the scorer should also caution the firer to stay on line with adjacent firers.

time, 2 training days are required to conduct Record Fire f and ff using one record range. To equalize light conditions, the half company which conducts Record Fire f in the morning of the first day should fire Record Fire ff in the afternoon of the second day. Conversely, the half company which conducts Record Fire ff in the afternoon of the first day should conduct Record Fire f in the morning of the second day.

b. *Range and Range Personnel.* There are four general areas needed to form a record range complex. These are an orientation area, ready area, firing area, and a retired area. The requirements for these areas, to include the necessary range personnel, are as follows:

(1) *Orientation area.* Location of the orientation area for record firing should be close to the firing area but should not allow the firer observation of the firing area. The orientation for record firing should include conduct of record fire,

instructions on safety and range operations to include procedures in the ready and retired areas, and scoring.

(2) *Ready area.*

(a) *Location and purpose.* The ready area should be located in the immediate vicinity of the firing range; however, firers should not be able to see the targets on the range from this area. While in the ready area, each soldier should be allowed sufficient time to slacken his rifle sights, lubricate the rifle as needed, and visually check his rifle for any apparent defects which might cause malfunctions. An ordnance small arms repairman should also be available in this area to service the rifles requiring repair.

(b) *Range personnel.*

1. *Noncommissioned officer in charge.* Supervises the activities of firers in the ready area.

2. *Ordnance small arms repairman.* Replaces damaged or broken parts discovered prior to or during record firing.

CAUTION: The replacement of any element of the sight system will change the ballistics of the weapon. When such replacements are made, the Ordnance repairman informs the noncommissioned officer in charge of the ready area so provisions for resetting the rifle can be made.

(3) *Firing area.*

(a) *Location and construction.* Ideally, a

record firing range should be located on ground which has a gradual downward slope for approximately 200 meters and then a gradual upward slope for an additional 110 meters, giving a total range depth of 310 meters. The standard record range (fig 117) is divided into 16 lanes, each 30 meters wide, with one foxhole in each lane. Stakes will be placed 25 meters from the first bank of targets and used for control points during the quick fire exercises (firing at the 25-meter target). The E- and F-type silhouette targets attached to target holding mechanisms are used for record firing. Seven targets are placed in each lane. Two targets are placed at a range of 50 meters from the line of foxholes. These two targets must be a minimum distance of 10 meters apart to insure that the firer does not employ aimed fire on quick fire targets. Subsequent targets are placed at 50-meter intervals out to 300 meters. For Record Fire I the F-type silhouette is used at ranges of 50 and 100 meters, and the E-type silhouette is used at all other ranges. For Record Fire II the two F-type silhouettes at 50 meters are replaced with E-type silhouettes. Targets must be placed in positions approximating those which enemy soldiers might occupy. They must not be completely hidden, but so situated that an alert observer can be expected to detect their location. In the raised position, however, targets must not provide a distinctive outline against the horizon or contrast with the background.

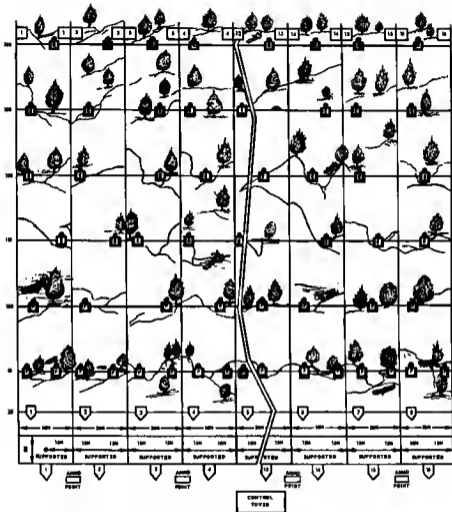

Figure 117. Standard record fire range.

(b) Range personnel.

1. *Officer in charge.* The senior officer on the range is responsible for the conduct of firing and the overall operation of the range complex.

2. *Safety officer.* He enforces safety regulations.

3. *Noncommissioned officer in charge.* He supervises and coordinates the actions of the target control operator, lane scorers, ammunition detail, target repairmen, and the non-commissioned officers in charge of the ready and retired areas.

4. *Lane scorers.* One lane scorer is required for each lane (total of 16 for the standard record range). The lane scorers have the following duties:

(a) Check the location and proper operation of targets within their lanes before firing begins.

(b) Point out the right and left flank limits of the lanes to each firer.

(c) Record the hits, misses, and no fires on the scorecard of each firer. Rule on the validity of alibis and the number of alibis to be fired (para 98 d). If in doubt, the lane scorers should request the noncommissioned officer in charge or the officer in charge to rule on the alibi.

(d) Require each firer to observe all safety precautions. During the moving phases of record firing, the lane scorer continually cautions the firer to stay on line with firers in adjacent lanes.

5. *Ammunition detail.* This detail is responsible for the issue and accounting of ammunition.

6. *Control tower operators.* They are responsible for raising and lowering the targets, timing their exposures, sounding the audible signal, and giving the fire commands. If possible, two men should be designated to perform these functions.

7. *Medical aidman.* Responsible for providing medical support as required and/or assist in the evacuation of the injured.

141 *Retired area.*

(a) *Location and purpose.* The retired area is located in the immediate vicinity of the firing range, usually about 100 meters behind the ready area. Soldiers completing record firing move to the retired area where they are checked for live ammunition and brass. They may also clean their rifles in this area.

(b) *Range personnel.* One noncommissioned officer is required to check firers for live ammunition and brass cartridge cases and supervise the cleaning of rifles.

98. *Conduct of Firing*

a. *Target Operation.*

111 *Control tower.* All targets are operated from the control tower. The control tower should be located in the center and slightly to the rear of the line of foxholes. It should be high enough to permit

the target control operator to observe firers conducting both supported and unsupported firing phases. For safety purposes, the tower should also be high enough to permit observation of the entire target area.

121 *Target exposure times.*

(a) In Record Fire I the soldier is confronted with both single and multiple target exposures. The firer has 5 seconds to engage a single target exposure between 50 and 200 meters, and 10 seconds to engage a single target exposure beyond 200 meters. The time for multiple target exposures depends upon the range to the targets. The firer has 10 seconds to engage double target exposures if both targets are 200 meters or less, and 15 seconds if one of both targets are beyond 200 meters. The firer has 20 seconds for triple target exposures.

(b) In Record Fire II the soldier is again confronted with single and multiple targets with the same time for engagement as in Record Fire I. Additionally the firer is confronted with two close-in targets simultaneously (25 meters) which he has 3 seconds to engage the close-in targets.

131 *Signals.* When the prescribed target exposure time has elapsed, the target control operator sounds a signal such as a bell, buzzer, or whistle which is audible to all firers and scorers. Rounds fired after this signal are scored as misses. To eliminate confusion resulting from targets being hit at the same moment the signal is sounded, target control operators must allow a few seconds interval between the signal and the actual lowering of targets.

Note. In order to provide maximum target and terrain situations, soldiers should fire Record Fire II on a lane different from that on which they fired Record Fire I.

6. *Record Fire I.* Record Fire I consists of four tables of ten target exposures each (fig 118). The firer is issued forty rounds (four magazines of 10 rounds each) and is instructed to engage each target with one round. Total possible points for Record Fire I is 40. During Record Fire I the firer is required to engage single and multiple targets from the foxhole supported and prone unsupported firing position.

111 *Table 1—*The firer engages 10 single target exposures from the foxhole supported firing position.

FIRER'S NAME (LAST)	(FIRST)	(M)	GRADE	SSN	UNIT	ORDER NO.
MORRIS	JIM	L	PVT 2	578444	COA	6
WRATHRR: RECORD I			TIME: RECORD I (AM PM) CROSS OUT ONR.			
RECORD II			RECORD II (AM PM) CEDSS OUT ONR.			
NIGHT RECORD						

RECORD I FOXHOLE POSITION TABLE 1. FIRING POINT NO.						RECORD I PRONG POSITION TABLE 3. FIRING POINT NO.					
RD	RANGE (M)	TIME (SEC)	HIT	MISS	NO FIRE	RD	RANGE (M)	TIME (SEC)	HIT	MISS	NO FIRE
1	200	5		✓		1	50	5	✓		
2	150	5		✓		2	200	5	✓		
3	250	10	✓			3	100	5			
4	300	10			✓	4	150	5	✓		
5	50	5	✓			5	300	10		✓	
6	150	5	✓			6	250	10		✓	
7	100	5	✓			7	20	5			✓
8	250	10		✓		8	200	5	✓		
9	200	5	✓			9	150	5	✓		
10	100	5	✓			10	250	10		✓	

RECORD I FOXHOLE POSITION TABLE 2. FIRING POINT NO.						RECORD I PRONG POSITION TABLE 4. FIRING POINT NO.					
PHASE	RANGE (M)	TIME (SEC)	HIT	MISS	NO FIRE	PHASE	RANGE (M)	TIME (SEC)	HIT	MISS	NO FIRE
1	100	15	✓			1	100	15	✓		
	150		✓				250		✓		
	300		✓								
2	50	15	✓			2	300	15	✓		
	150		✓				50		✓		
3	100	10	✓			3	200	10	✓		
	150		✓		✓						
4	100	20	✓			4	100	10	✓	✓	
	50		✓				300		✓		
	250		✓		✓						
5	300	5		✓		5	50	10	✓		
				✓			300		✓		
RECORD I TOTAL			HIT	MISS	NO FIRE	<i>Fred Rasmussen</i> SCORER'S SIGNATURE					
			26	10	4						

DA FORM 3595, 1 NOV 72

RECORD FIRER SCORECARD

REPLACES DA FORM 3595, 1 APR 75, WHICH IS OBSOLETE.

For use of this form, see Auth(Sec 23-72); the proponent agency is TRADOC.

1 Front

Figure 118. Record Fire Scorecard (DA Form 3595) with sample entries.

RECORD II

POXHOLE POSITION
TABLE 1. FIRING POINT NO.

PHASE	RANGE (M)	TIME (SEC)	HIT	MISS	NO FIRE
1	150	8	✓		
2	300	10			
3	150	10	✓		
	300		✓		
4	150	15	✓		
	300			✓	
5	150	20			
	300				✓
	200				
6	300	10			✓

OPTIONAL POSITIONS
TABLE 2. FIRING POINT NO.

PHASE	RANGE (M)	TIME (SEC)	HIT	MISS	NO FIRE
MO 1	100	10	✓		
	300			✓	
MO 2	250	15	✓		
	300				✓
MO 3	150	15	✓		
	180		✓		
MO 4	350	10	✓		
MO 5	300	10	✓		
MO 6	25	3	✓		
	25				✓

NIGHT FIRING RECORD
FOXHOLE OR PRONE SUPPORTED POSITIONS

RANGE	ROUNDS	TGT KILLS
25	1 - 30	10
50	21 - 25	9
TOTAL		19

OPTIONAL POSITIONS
TABLE 3. FIRING POINT NO.

PHASE	RANGE (M)	TIME (SEC)	HIT	MISS	NO FIRE
MO 1	100	20	✓		
	250			✓	
	150		✓		
MO 4	150	10	✓		
	300		✓		
MO 3	150	10	✓		
	300			✓	
MO 4	25	3	✓		
	25		✓		
MO 5	25	3	✓		

NO FR. MOVE OUT (MO)

OPTIONAL POSITIONS
TABLE 4. FIRING POINT NO.

PHASE	RANGE (M)	TIME (SEC)	HIT	MISS	NO FIRE
MO 1	150	15	✓		
	300			✓	
MO 2	150	20	✓		
	200		✓		
	250			✓	
MO 3	25	3	✓		
MO 4	25	3	✓		
	25		✓		
MO 5	25	3	✓		
	25				✓

RECORD FIRING I	RECORD FIRING II	RECORD NIGHT FIRING	QUALIFICATION SCORE
26	26	19	71

QUALIFICATION (CIRCLE ONE):
EXPERT, SHARPSHOOTER, MARKSMAN, UNQUALIFIED

RECORD II TOTALS	HIT	MISS	NO FIRE	SCORER'S SIGNATURE
	26	11	3	Frank Foster

QUALIFICATION SCORES AND RATING:
 POSSIBLE 100
 EXPERT 75 - ABOVE
 SHARPSHOOTER 64 - 74
 MARKSMAN 54 - 63
 UNQUALIFIED 53 - BELOW

OFFICER'S SIGNATURE
 [Signature]

2 Back

Figure 118—Continued.

(2) Table 2—The firer engages single and multiple target exposures from the foxhole supported firing position.

(3) Table 3—The firer engages 10 single target exposures from the prone unsupported firing position.

(4) Table 4—The firer engages single and multiple target exposures from the prone unsupported firing position.

(a) Foxhole position phase of Record Fire I.
 1. After receiving an orientation and

completing preparations in the ready area, the soldier moves to the firing area. The soldier moves to his designated lane and stands or sits behind the foxhole facing away from the target area. On command, the firer hands his scorecard to the lane scorer and moves into the foxhole. There should be at least three sandbags at each foxhole so the firer can adjust the emplacement to fit the conformation of his body. After making these adjustments, the firer should be given time to search his lane, using those techniques learned in target detection

training. Targets must not be raised while the firer is performing this search. However, the lane search will familiarize him with the terrain, likely target locations, and most important, place added emphasis on previous target detection training.

2. On command, the firer is issued one magazine of 10 rounds and loads his rifle. The target control operator then gives the command WATCH YDUII LANES. Immediately following this command, the target operator begins raising and lowering targets according to the time and sequence prescribed by the scorecard (fig 1181). Ten targets are presented in the firer in each table of Record 1 and he may fire only one round at each target. Upon completion of Tables 1 and 2 of Record 1, to include alibi firing (d below), the target control operator requires a safety clearance of the firing line. At this time, the firer clears his rifle and returns unexpended ammunition to the lane scorer. The lane scorer checks to insure the rifle is clear and directs the firer to get out of the foxhole and assume a mud prone position beside the foxhole.

(b) *Prone position phase of Record Fire I.* Tables 3 and 4 (scorecard) are fired from the prone position. They are conducted in the same manner as Tables 1 and 2, with the exception that the firer is in the prone position instead of the foxhole position. Upon completion of Tables 3 and 4 of Record Fire 1, to include alibi firing, the target control operator requires a safety clearance of the firing line. At this time, the firer clears his rifle and returns all unexpended ammunition to the lane scorer. The lane scorer checks to insure the rifle is clear, hands the firer his scorecard, and directs him to the reload area.

c. *Record Fire II.* Record Fire II consists of four tables of ten target exposures each (fig 1181). The firer is issued 40 rounds (four magazines of 10 rounds each) and is instructed to engage each target with one round. Total possible points for Record Fire II is 40. During Record Fire II the firer is required to engage single and multiple targets from the foxhole firing position (table 1) and from an optional firing position while advancing from the foxhole towards the target line (tables 2, 3, and 4). Additionally, the firer is required to engage 10 quick fire targets (two in table 2, three in table 3, and five in table 4). The quick fire targets are to be exposed and engaged when the firer reaches a point of 25 meters from the target line (para 97, b 134 (a)).

(1) *Foxhole position phase of Record Fire II (Table 1).* The foxhole position phase consists of one table with both single and multiple targets. The conduct is the same as the foxhole position phase of Record Fire 1.

(2) *Optional position and move out phase (Tables 2, 3, and 4).* When the firer completes the

first table, he again receives the command to get out of the foxhole. This time, however, he is told to move to a standing position directly in front of the foxhole. The lane scorer takes up a standing position immediately behind the firer. On command, the firer is issued one magazine of 10 rounds and loads his rifle. The command to begin the exercise is MOVE OUT. On this command, the firer and scorer begin moving slowly toward the 50-meter targets. The target control operator begins raising and lowering targets according to the times and sequence prescribed by the scorecard. As the firer detects a target, he assumes a position of his own choice and fires at the target. As is the supported phase, he may fire only one round at each target. After firing at a target, the firer may change his position, but he must not move forward until he receives another command to MOVE OUT. While waiting for this command, the firer should continue to search his lane since other targets may appear. The firers should be on line with the 25-meter stakes prior to engaging the quick fire targets. During movements, the lane scorer continually cautions the firer to maintain alignment with firers in adjacent lanes and to keep his weapon locked when not firing. The procedures for clearing rifles are the same as prescribed for the supported firing phase.

d. *Alibi Firing.* Alibi firing is reserved for those firers who have encountered bonafide alibis. An alibi is to be awarded under the following circumstances:

111 Malfunctioning of rifle (e.g., broken firing pin, double feed, failure to extract), provided the firer attempted to apply correct immediate action to eliminate the stoppage. Alibis for malfunctions are valid only if they were not due to improper maintenance or failure to prepare the rifle for firing. A general rule to follow in awarding alibis for rifle malfunctions is to allow an alibi for each target appearing during and subsequent to the moment the firer applies immediate action, provided the target drops before the soldier ran fire. However, if the firer was slow in taking action to reduce the stoppage, an alibi should not be allowed.

124 Faulty ammunition.

131 Malfunction of the target holding mechanism (e.g., target fails to appear, target remains in the UP position, or target appears and falls without having been engaged).

141 In no instance will an alibi be given when the firer fails to detect and/or engage a target(s) in the prescribed time limit.

c. *Conduct of Alibi Firing.* If a firer is unable to fire at a target through no fault of his own, he receives an alibi for that particular target. This means he will be given another opportunity to fire at a target. For best results, alibi firing should be

conducted after each exercise. To conduct alibi firing, the target control operator first asks, "Are there any alibis?" Those scorers whose firers whose firers have bona fide alibis give an affirmative signal raising their hands or holding up the scorecard. If there are alibis, the target control operator commands, **ALIBI FIRERS WATCH YOUR LANES.** Targets are then exposed singly. As a general rule, alibi firing should be conducted using midrange targets (150 to 250 meters), as the majority of the targets exposed during the regular exercises are located at these ranges. Since alibi firing can never approximate the identical target situation of the regular exercise, range personnel must insure alibis are legitimate before they are allowed. The firer should be allowed to fire only one round for each alibi. Alibi granted during engagement of quick fire targets must be fired at the same range (25 meters) using the same method of target engagement (quick fire). Quick fire alibi firing should be conducted separate from regular alibis with the target control operator announcing, "Quick fire alibis only."

f. Fire Commands. Simple, standardized fire commands are essential to avoid confusion and misunderstanding during the conduct of record firing. Type commands which may be used are as follows:

111 *Supported phases.*

**FIRES ASSUME THE
FOXHOLE / PRONE POSITION.
SCORES POINT OUT THE LIMITS OF
THE LANES.**

Section III. RECORD FIRE—NIGHTTIME

99. General

The soldier's inability to successfully detect and engage targets during periods of limited visibility has always been a major concern of commanders. To help overcome this handicap more time has been devoted to the fundamentals and their application, practice firing during periods of darkness, and subsequently the soldier's proficiency is tested in night record qualification. The night qualification score is then added to the day qualification score and a qualification rating is awarded on the basis of the combined score. Qualification criteria will be discussed in para 106f.

100. Fundamentals

a. Target Detection. Trying to detect a target during the day is difficult enough but at night it becomes even more difficult. In order for a soldier to see targets at night, he must apply the three principles of night vision. (For more detailed information on the three principles of night vision see FM 21-75.)

**LOCK; WITH ONE MAGAZINE OF
TEN ROUNDS, LOAD.**

WATCH YOUR LANES.

CEASE FIRING.

ARE THERE ANY ALIBIS?

**ALIBI FIRERS WATCH YOUR
LANES.***

CEASE FIRING.*

CLEAR ALL WEAPONS.

CLEAR ON THE RIGHT?

CLEAR ON THE LEFT?

THE FIRING LINE IS CLEAR.

(2) *Unsupported phases.*

**FIRES, STAND IN FRONT OF THE
FOXHOLE.**

**LOCK; WITH ONE MAGAZINE OF
TEN ROUNDS, LOAD.**

MOVE OUT.

CEASE FIRING.

ARE THERE ANY ALIBIS?

**ALIBI FIRERS WATCH YOUR
LANES.***

CEASE FIRING.*

CLEAR ALL WEAPONS.

CLEAR ON THE RIGHT?

CLEAR ON THE LEFT?

THE FIRING LINE IS CLEAR.

Caution: The control tower operator will orally command "LOCK ALL WEAPONS" prior to all move out commands.

* Note: Commands given only if alibis are indicated by scores.

(1) *Dark adaptation.* This is the process which conditions the eyes to see under low levels of illumination. It takes the eyes of the average person approximately 30 minutes to become 98 percent dark adapted in a completely darkened area.

(2) *Off-center vision.* During the daytime when an individual looks at an object, he looks directly at it. However, if he did this at night he would only see the object for a few seconds. In order to see this object for any length of time, he must look 6 to 10 degrees away from this object while concentrating his attention on the object.

(3) *Scanning.* The act of scanning relates to the short, abrupt, irregular movement of the firer's eyes every 4 to 10 seconds around an object or area.

b. Firing Position. The recommended firing position for use during periods of limited visibility is the prone supported position (fig 119). This position, when used during periods of limited visibility, differs slightly from the prone supported position discussed in chapter 3. The reason for this

is that an individual cannot use his sights during periods of limited visibility. To effectively engage targets during periods of limited visibility, the firer assumes the prone supported firing position discussed in chapter 3, reestablishes a raised stock weld (looks 2 to 3 inches above the sights on a level plane with the barrel), points the weapon at the target, and fires. To obtain optimum results the firer should keep both eyes open and his head, and rifle should move as one unit.

101. Training Facilities and Equipment

a. *Range Construction.* When constructing a night fire range the following factors must be considered:

11) Construct on level or slightly rolling terrain. It should be away, or shielded, from artificial light sources.

12) Have a dark background to prevent silhouetting the targets.

13) Have an approximate depth of 100 meters. To aid in individual target identification, the lateral distance between the target holding mechanisms and firing points should be a minimum of 5 meters. (When sufficient terrain facilities are available the lateral distance may be increased proportionately.)

14) Firing line and target should be on the same plane.

15) Funding and / or terrain restrictions may necessitate variations in range construction; however, the examples listed below will generally satisfy all circumstances:



Figure 119. Prone supported night fire position for M14 rifle(s)

(a) Figure 120 illustrates a range capable of accommodating 50 firers simultaneously. This range features one bank of 50 targets (5 meters apart) and two firing lines. Troop movement is to the rear from the 25 meter firing line to the 70-meter firing line. This range configuration requires 50 M31A1 target holding mechanism and four M40 counter devices.

(b) Figure 121 illustrates a range capable of accommodating 50 firers simultaneously, but it differs from the range in figure 94 in that there are two banks of targets (50 targets at 25 meters, and 50 targets at 50 meters) and one firing line which eliminates the requirement for troop movement during the conduct of firing. This range configuration requires 100 M31A1 target holding mechanisms and eight M40 counter devices.

(c) Figure 122 illustrates a range capable of accommodating 50 fires simultaneously, but it differs from the ranges discussed in figures 117 and 188 in that there are two banks of targets (25 targets at 25 meters, and 25 targets at 50 meters) and one firing line with troop movement being lateral. This range requires 50 M31A1 target holding mechanisms and fifty M40 counter devices.

Note: Each of the range configurations discussed above have advantages and / or disadvantages over each other in a given situation. The selection of one over the other is a local decision and will be dictated by the local conditions (i.e., finding and terrain available).

b. Logistics.

(1) The range used for night record fire must

be equipped with the modified M31A1 target holding mechanisms and the M40 counter devices. Targets used should be the standard E-type silhouette, fastened to the modified M31A1. The M31A1 should be countersunk to a point where it does not protrude above ground level when the target is in the down position (fig. 123). If for some reason the M31A1 target holding mechanisms must be installed above ground level, a protective berm must be built in front of them. The protective berm should be no higher than 1 foot. A piece of boiler plate or concrete slab should be placed within the berm to preclude the berm from being eaten away by prolonged firing (fig. 124).

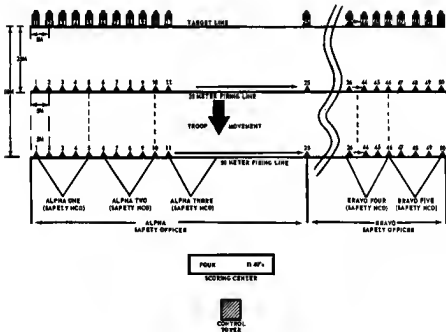

Figure 125. Night fire range (troop movement to rear).

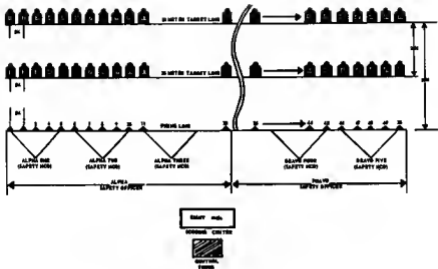

Figure 131. Night firing range (no troop movement required).

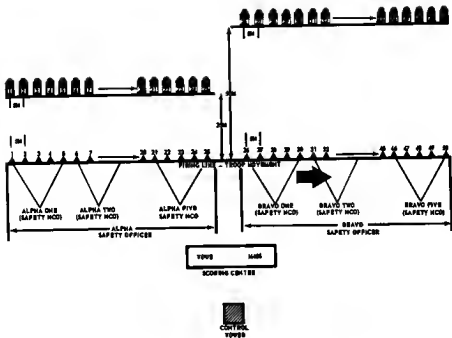

Figure 133. Night firing range (lateral troop movement).



Figure 125. Countermine M31A1 target holding mechanism.

12) A dual light system should be established for expediency and safety purposes. Red or black lights should be used as needed during the conduct of training. Normal white lights should be used only for emergency purposes and police of the range after firing.

13) Red filtered flashlights are used on the firing line by the safety NCO and safety officers.

14) To facilitate orientation and issuance of fire commands, a public address system is used. An alternate method should also be devised for a cease fire should the need arise (flares, strons).

15) A 4-inch square piece of reflective material

(luminous tape or used multilith plate) is attached to the center of mass of the standard K-type silhouette target (fig 125).

16) To assist the firer in identifying his target it is recommended that the odd numbered target indicator lights use the amber or reddish lens assembly which comes with the M 40 systems and the even numbered target indicator lights use a blue lens assembly. The blue lens assembly is available through supply channels under the manufacturer number 51-8434-200.

17) The indicator light assembly must be modified and will be discussed in paragraph 111.

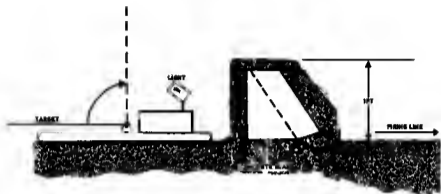

Figure 124. M31A1 target holding mechanism with berm.



Figure 125. E-type silhouettes with reflective material

102. Organization of a Night Record Fire Range

a. *Range Safety.* All live firing exercises have a degree of danger associated with them. Night firing exercises can be extremely hazardous unless the range is properly organized and the firers are closely supervised. As a guide in establishing the organization of a night record range and the personnel required to meet the minimum supervisory and/or safety requirements, the following may be used:

(1) *Range organization.* The firing points on the night record range should be divided into alphabetical sections with no more than 25 firing points in each section (fig 120, 121, 122). Each section (25 firing points) is then designated Alfa section, Bravo section, and so on. Each section is further divided into blocks of five firing points each. These blocks are given a letter and numerical designation. For example, there are 25 firing points or five 5-point blocks in Alfa Two, and so on. A safety officer should be assigned responsibility for each alphabetical section, and one safety non-

commissioned officer should be assigned responsibility for each numerical block.

(2) *Range personnel.*

- (a) One officer in charge of the range.
- (b) One safety officer per alphabetical section.
- (c) One noncommissioned officer in charge.
- (d) One safety NCO per numerical block.
- (e) Ammunition detail.
- (f) Medical personnel.
- (g) Two control tower operators.
- (h) Scorers (one per M40 counter device).
- (i) Guards as prescribed by local policy.

Note: Although some modifications in the organization of the range may be required, night firing should not be attempted without an adequate number of supervisory and safety personnel.

b. *Organization of Firers.* Firers are divided into orders (one firer per firing point). The first order moves to the firing line while subsequent orders remain on the ready line until called forward to fire.

103. Conduct of Firing

a. Initially, firers are given a review of the pointing technique and the principles of night vision. This is followed by an orientation on safety aspects and range procedures.

b. The first firing exercise is for practice. Targets are exposed at a range of 25 meters with each soldier firing six rounds. The first and fourth rounds should be tracers to aid the firer in obtaining weapons alignment on target. Targets are initially in the UP position. At the command COMMENCE FIRE, the tower operator, controlling the targets, counts 20 seconds, pushes the switch that controls the targets, to the UP position, and releases it. Firers are instructed to fire only one round at each target exposure.

c. At the completion of 25-meter practice firing the soldier is ready to begin the record fire exercise at 25 meters. He is issued one magazine containing 10 rounds and is instructed to fire at each of 10 target exposures. As in practice firing, the targets are initially in the UP position and the tower operator raises them every 20 seconds. Targets are to be exposed only 10 times.

d. Upon completion of the 25-meter record fire exercise the scores are recorded from the M40 counter device (para 103) and the 50-meter exercise is initiated (i.e., six rounds for practice followed by 10 rounds for record). The 50-meter exercise is a repeat of 25-meter exercise with the exception of the distance to the targets.

e. At the completion of the 50-meter record fire exercise the scores again are recorded from the M40 counter device and each firer is informed of his score.

Note. Targets should never be lowered by the tower operator during the conduct of the record fire exercises (para 105d) or prior to firing alibis.

f. Alibis must be fired after the completion of each exercise or prior to the changing of firing lines.

g. Distribution of ammunition for the conduct of firing may be accomplished by having each firer pick up, from a central issue point, two magazines of six rounds each (for practice firing) and two magazines of ten rounds each (for record firing). After each order has completed firing the entire course, the magazines are returned to the central point. This procedure may be modified to fit local conditions.

104. Fire Commands

Fire commands should be simple and include only that information and instruction required. A sample fire command for night practice fire and night record fire is as follows:

a. ARE RANGE PERSONNEL READY TO FIRE? (Block safety NCO's signify UP to section safety officers; safety officers in turn signify UP to the tower operator; e.g., Alpha UP, Bravo UP). Safety personnel may show readiness by oral or visual (red light) signals.

Note. This procedure may be modified to conform to local safety SOPs.

b. IS THERE ANYONE DOWN RANGE?
(Ask three times).

c. THE FIRING LINE IS NO LONGER CLEAR.

d. ORDER _____, MOVE TO THE FIRING LINE. PLACE YOUR WEAPON NEXT TO THE STAKE OF YOUR ASSIGNED FIRING POINT AND ASSUME A GOOD NIGHT FIRE POSITION; THEN SECURE YOUR WEAPON.

e. IS THE FIRING LINE READY? (Block safety NCO's signify UP to their respective safety officers; safety officers in turn signify UP to the tower operator).

f. THE FIRING LINE IS READY.

g. SAFETY NCO's INSURE ONE MAGAZINE OF SIX ROUNDS (one magazine of 10 rounds for record fire).

h. FIRER'S: ONE MAGAZINE OF SIX (10) ROUNDS; LOAD.

i. UNLOCK YOUR WEAPON.

j. TARGETS UP (a slight hesitation to allow firer to point toward target).

k. COMMENCE FIRING (targets raised six times at 20 second intervals for practice) (10 times at 20 second intervals for record fire).

l. CEASE FIRE.

m. ARE THERE ANY ALIBIS? If so, alibis are fired; para 103f).

n. LOCK AND CLEAR ALL WEAPONS.

o. FIRERS REMAIN IN POSITION UNTIL CLEARED BY SAFETY NCOs.

p. IS THE FIRING LINE CLEAR? (Block NCOs signify UP to their respective safety officers, and safety officers signify UP to the tower operator).

q. THE FIRING LINE IS CLEAR. Repeat commands for record fire of the 25-meter and 50-meter exercises.

105. SCORING NIGHT RECORD FIRE WITH THE M40 NIGHT FIRING MECHANISM

a. The M40 night firing mechanism consists of the following components (fig 126).

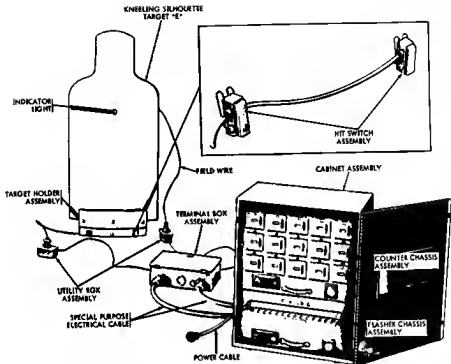

Figure 126. Night firing target mechanism M40—components and assemblies.

- (1) The cabinet assembly.
- (2) The counter chassis assembly.
- (3) The flasher chassis assembly.
- (4) The terminal box assembly.
- (5) The target holder assembly (not used for night record fire, as it is already present on the M31A1 target holding mechanism).
- (6) The hit switch assembly (not used when employed in conjunction with the M31A1 as it is already present on the M31A1 target holding mechanism).
- (7) Indicator light (see modification instruction for M31A1 target holding mechanism).

b. Scores for night record fire are recorded automatically on the M40 counter device. Each device is capable of recording scores for 15 firing points (M31A1 target holding mechanism). The target will fall when hit by a projectile. Each time

the target falls the score is increased by one and is registered on the M40 device. After each exercise the scores are transferred by a scorer from the M40 to a scoresheet, the counters are turned back to zero, and the next exercise is conducted.

c. The scorer must turn off the counter assembly immediately after all alphas have been fired and the command CEASE FIRE has been given. The purpose of this procedure is to insure accurate scoring, as any actuation of the M31A1 target mechanism will be recorded by the M40 night firing mechanism, this includes the lowering of the target by the tower operator. The tower operator should allow ample time between the command CEASE FIRE and the actual lowering of the targets; this provides the scorers with sufficient time to turn off his respective machine. The scorer then records all hits for each firing point on a

master scoresheet (fig 127), and resets all counters to zero prior to the firing of the next exercise.

NIGHT RECORD SCORES											
COMPANY _____					DATE FIRED _____						
RANGE _____					WEATHER CONDITION _____						
NAME OR ROSTER NO.	ORDER NO.	POINT NO.	25M HITS	50M HITS	TOTAL	NAME OR ROSTER NO.	ORDER NO.	POINT NO.	25M HITS	50M HITS	TOTAL
		1						26			
		2						27			
		3						28			
		4						29			
		5						30			
		6						31			
		7						32			
		8						33			
		9						34			
		10						35			
		11						36			
		12						37			
		13						38			
		14						39			
		15						40			
		16						41			
		17						42			
		18						43			
		19						44			
		20						45			
		21						46			
		22						47			
		23						48			
		24						49			
		25						50			
REMARKS:											

Figure 127. Night firing scoresheet (locally fabricated).

d. The flasher assembly is preset to control the indicator lights mounted on the M31A1 in a

manner to emit a flash of light every 4 seconds. This gives the firer five flashes for every target

exposure. The mode of the flash may be set to either the single or rapid mode.

106. Qualification Scores and Ratings

a. Qualification scores for rifle marksmanship are based on a possible 100 points and include 70 possible points for *daylight aimed fire*, 10 possible points for *daylight quick fire*, and 20 possible points for *night fire*. Every effort will be made to insure that scoring is accurate and opportunities for error are minimized. Qualification scores and ratings are:

Expert 75-100

	Score	Action to be taken
Record Fire I	Less than 20	Retire Record I on a contingency basis. ¹
Record Fire I	More than 20	Progress to Record Fire II.
Record Fire I and II Total	Less than 47	Retire Record Fire II on a contingency basis. ²
Record Fire I and II Total	More than 47	Progress to Night Record Fire.
Record Fire I, II and Night Fire Total	53 or below	Retire Night Record Fire. ³
Record Fire I, II and Night Fire Total	54 or more	Award qualification rating as indicated in paragraph 3h.

¹ An individual who scores less than 20 on Record Fire I will be retired on a contingency basis before proceeding to further scheduled marksmanship training and qualification firing. This retire score will be disregarded if it is not used to obtain the minimum qualification score of 46 (the total score of Record I, Record II, and Night Record).

² An individual who attains a combined score of less than 47 (original or retire score for Record I plus the original score for Record II) will retire Record II on a contingency basis. This retire score will be disregarded if it is not used to obtain the minimum qualification score of 46 (the total score of Record I, Record II, and Night Record).

³ An individual who has not attained a combined minimum score of 53 (Record I—original or retire score—plus Record II—original or retire score—plus original Night Fire score) will retire Night Record Fire. If after retiring Night Record Fire the individual's total score is less than 54, 1/2 below shall apply.

(3) The use of any retire score (I, II, or Night Fire) to obtain the minimum qualification score of 54 will result in the firer receiving a maximum qualification rating of **MARKSMAN**. Expert and sharpshooter qualification ratings are reserved for those individuals who obtained the required number of hits through the use of the original scores only.

Sharpshooter 60-74
 Marksman 54-65
 Unqualified 53 and below

b. Qualification requirements procedures.

(1) Individuals must fire Record Fire I, Record Fire II, and Night Record Fire exercises and achieve a combined minimum qualification score of 54.

(2) To assist in recognizing individuals who are not reaching the minimum proficiency at critical points in the Record Fire course, the following guides are established.

(4) If after firing all three exercises (including retire of exercises) as described above an individual has not attained the specified minimum qualification score (54), and thereby achieved remediation, he should be provided intensive remedial training. Subsequently, he should be retired once on one or more exercises as necessary to achieve the minimum qualification score of 54.

Section IV.

PROCEDURES FOR CONNECTING 15 MODIFIED M31A1 TARGET HOLDING MECHANISMS TO ONE M40 COUNTER DEVICE, AND MODIFICATION OF THE M31A1 MECHANISM

107. General

Connecting the M31A1 target holding mechanism to the M40 counter device enables the firer to engage a target and ascertain the results without moving down range. This ideal for night firing as it is both expeditious and safe. Fifteen M31A1 target mechanisms may be connected to one M40 night firing device.

108. Procedures for Connection of System

a. Punch out the upper perforated circles on the left, middle, and right of the terminal box.

b. Insert lug ends of the electrical special purpose cable assembly (fig 128) (FSN 6920-862-4759) into the right and left holes (a above). Connect the ground wire to the common section and one each lug terminal to each terminal on the terminal board (fig 128) marked "Hit Switches." Repeat the above procedure with the second special purpose cable to connect the lights.

c. Lay two 15-pair conducting cables from the scoring center terminal box down range to the vicinity of the berm.

d. Strip the insulation back $\frac{1}{2}$ -inch at both ends on each conductor wire of the two 15-pair conductor cables.

e. Select one set of two conductors from a 15-pair conductor cable. Attach one conductor under the screw numbered 1 on the "Hit Switch" terminal board.

f. Select one set of two conductors from the other

1 cable. Attach one conductor under the screw numbered 1 on the "Lights" terminal board and the other conductor under the corresponding screw on the "Common" terminal board.

g. Repeat the procedure in a and f above for each M31A1 to be used (up to 15 per each M40 device).

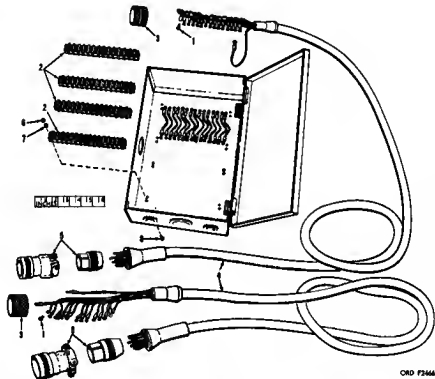

ORD F2466

- 1-Lug terminal 8940-304-7830
2-Terminal board 6940-109-2583
3-Electrical conduit coupling nut 8975-821-6448
4-Electrical special purpose cable assembly 6920-862-4759

- 5-Electrical plug connector 8935-301-6885
6-Hexagonal plain nut 8310-271-4644
7-Lockwasher 8310-309-0788
8-Machine screw 6305-543-8763

Figure 128. Electrical special purpose cable assembly.

h. Take an additional terminal box and set it up behind the target line in a desirable location.

i. Connect the other ends of the two 15-pair

cables to this second terminal box in the respective positions occupied on the terminal box at the arming center. It is important that each wire is

connected to its corresponding connection to insure correct scoring.

j. Cut two lengths of 2-conductor wire sufficient to reach from the M31A1 to the terminal box behind the target line.

k. Remove 1/4-inch of the insulation from both ends of the wires.

l. Attach one of the conductors from a 2-conductor wire to the "Hit Switch" terminal board and the other conductor in the common terminal board insuring that it is connected on the number on the terminal boards corresponding to the number of the target or firing point. Attach one of the conductors of the wire just installed to the binding post marked "L" on the M31A1 and the other conductor to the binding post which was added per modification.

or. Attach one conductor of the remaining 2-conductor wire to the "Lights" terminal board and the other conductor to the common terminal board; again insuring, as in *l* above, they are connected to the number appearing on the terminal board corresponding to the number of the target or firing point. These wires are then connected to the indicator lights for the target (fig. 129).

109. Alternate Method

An alternate method can be used utilizing the utility boxes provided with the M40. Attach two wires to "Hit Switch" and "Common" terminals, as in *l* above, then two wires to "Lights" and "Common" terminals as in *m* above, and attach a utility box to each set of the wires just installed at the target location. Label one utility box "Lights" and the other one "Hit Switch."

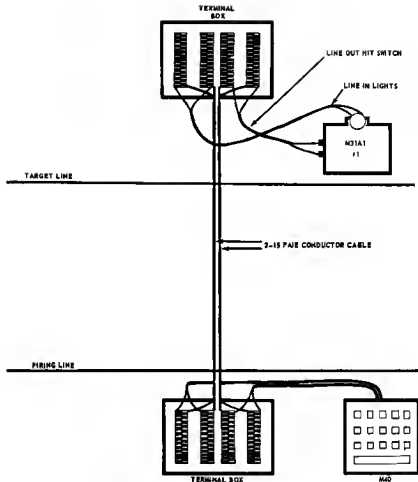

Figure 129. Wiring diagram—firing line to target line.

- a. Cut two 36-inch lengths of two-conductor wire.
- b. Attach an electrical plug to one end of each wire.
- c. Attach one wire to the indicator light and plug into utility box tagged "Lights."
- d. Attach one conductor of the remaining wire to the binding post labeled "L" on the M31A1 and

one conductor to the binding post which was added per modification, and plug into the utility box tagged "Hit Switch."

110. Utility Box Storage

The utility boxes may be stored in a small ammunition can by cutting a $\frac{1}{4}$ -inch slot in the side of an ammunition can. Place the utility boxes in the

can lay the wires in the slot and secure the cover. Sealing wax may be used to seal out moisture.

111. Modification of Indicator Light (M31A1 Mechanism)

The indicator light is susceptible to damage if used in a position centered on the target as indicated in figure 123. Therefore, it should be removed from the target, placed within a metal cylinder here called, and attached to the front of the M31A1 target holding mechanism by way of a locally fabricated

holder (fig 130). This facilitates the aiming of the indicator light onto the target.

112. Damage Prevention

The aimed cylinder directs flashes of light upon a 4-inch square of reflective material attached to the silhouette (fig 125), thus, preventing accidental damage caused by a round striking the indicator light.

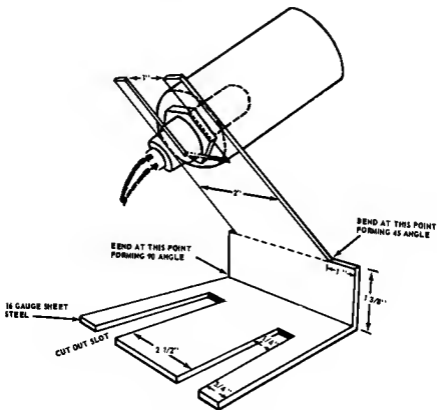

Figure 130. Indicator light bracket (locally fabricated).

ADVANCED RIFLE MARKSMANSHIP

Section I. FUNDAMENTALS

113. General

The purpose of advanced rifle marksmanship training is to enable selected personnel to obtain a high degree of proficiency and expertise that is not normally required of the average rifleman. To be able to obtain a first round hit on targets at varying extended ranges, the firer must be highly skilled in applying the fundamentals of marksmanship to include aiming, position, trigger control, sight adjustment, effects of weather, and zeroing. It should be a requirement that every firer periodically refamiliarize himself with these fundamentals regardless of his shooting experience. Even the experienced firer will develop a deficiency from time to time in the application of fundamentals that is often masked by perfection of other fundamentals. The fundamentals taught in advanced rifle marksmanship differ from those taught the average soldier only in degree. In order for the firer to achieve the high degree of perfection desired in advanced rifle marksmanship, he should be equipped with the best weapon and ammunition available. The sniper's weapon in the US Army is a national match grade M14 rifle, selected for accuracy, and renamed the M21 rifle. It is equipped with a telescopic sight, but also retains the iron sights.

114. Aiming

The first fundamental taught to the firer is aiming. It is one of the most important fundamentals and provides a means whereby the firer can check the effectiveness of his position and trigger control in later phases of training and shooting. Instruction in aiming is divided into five phases: relationship between the eye and sights, sight alignment, sight picture, breathing and aiming process, and aiming exercise. The explanation of these phases is designed to supplement that found in chapter 3.

a. *Relationship Between the Eye and Sights.* Variations in the position of the eye with respect to the rear sight will cause variations in the image received by the eye. The placement of the eye is called "eye relief." Proper eye relief, subject to minor variations, is approximately 7.5 cm (3 in). When using the sniper scope (fig 13 f), the eye relief is approximately 9 cm (3½ in) (fig 132). The best

method of fixing eye relief is with the spot weld. To clarify the use of the eye in the aiming process, one must understand that the eye is capable of instantaneous focus from one distance to another. It cannot, however, be focused at two distances simultaneously. To achieve an undistorted image while aiming, the firer must position his head so that he looks straight and not out of the corner or top of his aiming eye. If the head position causes the shooter to look across the bridge of his nose or out from under his eyebrow, the eye muscles will be strained. This strain will produce involuntary eye movement which reduces the reliability of vision. This will not only affect performance, but the inability to see will also have a damaging psychological effect upon the firer. The eye will function best in its natural forward position. Do not fix vision on the sight picture for more than several seconds. When the eyes are focused on a single image for a time, the image is burned into the area of perception. This can be illustrated by staring at a black spot on a piece of paper for 20 to 30 seconds and then shifting the eyes to a white wall or ceiling. A ghost image of the black spot will appear, with a corresponding loss of visual activity to the area of the image. This effect upon the firer's eye is quite important. A burned-in sight picture will dull visual activity in the critical area of perception, and this image may possibly be mistaken for a true sight picture. Either effect will seriously restrict performance.

b. *Sight Alignment.* Sight alignment is the relationship between the front and rear sight with respect to the eye. This is the most important aspect of aiming, as errors in alignment create angular changes in the position of the axis of the bore in relation to the line of sight. When using an aperture rear sight and a post front sight, center the top of the front sight post horizontally and vertically to the rear aperture. It has been found that this is the natural method of aligning sights. When using the sniper scope, the firer must have a clear field of view. Any shadow effects (fig 133) indicate misalignment.

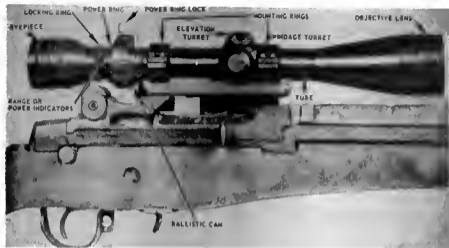

Figure 131 Supercope with mount.



Figure 132 Eye relief

c Sight Picture. With both the iron and the optical sight the firer aims at the center of visible mass of the target (fig 134). Further, the rifle must not be canted. Canting is the act of tipping the rifle to either side of the vertical. Figure 135 shows a proper sight picture in which the rifle, or scope sights and the rifle barrel, are in vertical alignment. Figure 135 shows the relation between the firer's line of sight and the line of elevation of the rifle barrel (line of shot). As the bullet leaves the rifle, it is headed for point A, but the force of gravity causes it to drop and strike the target at point A-1, the desired point of impact. Figure 135 illustrates a canted rifle; the sights are tipped slightly to the right. In this instance, the firer's line of sight still terminates at point A-1 on the target, but the line of the shot now points to B instead of to A. The bullet

drops identically as in the first shot but the drop is from point B and the impact is at B-1. A more pronounced cant will move the bullet strike farther out and down as shown in the inset, figure 135.

d Breathing and Aiming Process. If the firer breathes while trying to aim, the rise and fall of his chest will cause the rifle to move vertically. Sight alignment is accomplished during breathing but to complete the process of aiming, the firer must be able to hold his breath. To properly hold his breath, the firer inhales, then exhales normally and stops at the moment of natural respiratory pause (fig 136). If the firer does not have the correct sight picture then he must adjust his position so that he can obtain the correct sight picture without the use of muscular strain to hold the weapon. The breath should not be held for longer than 10 seconds since

this results in dimming vision and increasing muscular tension. While exhaling and holding the front sight up to the target, the focus should be repeatedly shifted from the front sight to the target until the firer determines that he has a correct sight picture. When the sight picture has been obtained, the focus should remain on the front sight until the

round has been fired. Final focus must be on the front sight to call the shot accurately and detect variations in sight picture and sight alignment. Under adverse light conditions, when the target appears indistinct, the firer has a tendency to focus beyond the front sight at the target. That must be avoided.

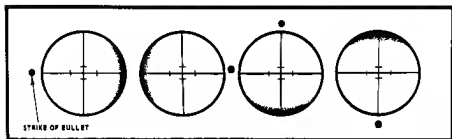

Figure 133. Shadow effects optical sights.

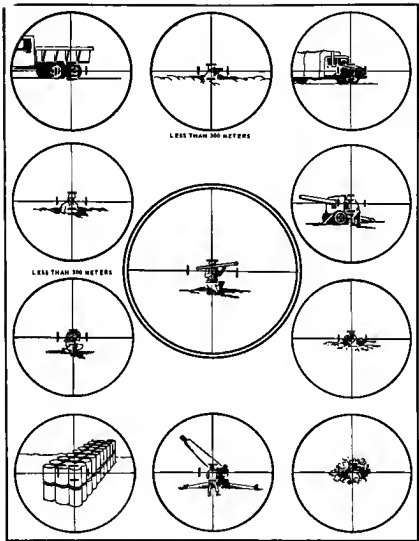

Figure 134. Sample night pictures (optical sights).

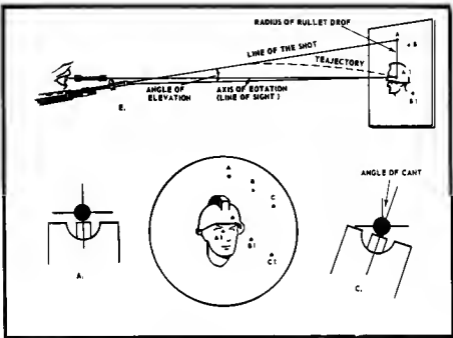

Figure 135. Canting the rifle.

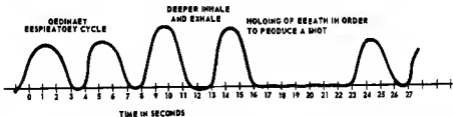

Figure 136. Respiratory pause.

e. *Aiming Exercises.* Various aiming exercises can be found in chapter 4.

115. Positions

The firer should select the position that offers him stability, observation of the target, and concealment. The firer should be able to deliver accurate fire from any of the standard firing positions.

The firing positions will be improved when used with the loop sling. While the use of the sling is not necessarily advocated for use in combat, this should be left to the firer to decide depending on his situation. Its use should be stressed in advanced rifle marksmanship instruction to the same degree as firing from the supported positions.

a. *Sling Adjustment.* To adjust the loop sling for a right-handed firer, place the butt of the rifle on the right hip and cradle the rifle in the crook of the right arm. This leaves both hands free to adjust the sling. Unhook the sling from the lower sling swivel; draw with the huckle down on the hook, feed the sling through the top of the buckle forming a loop (Fig. 137). Give the loop a half turn to the left and insert the left arm through the loop positioning it well up on the arm above the bicep. Tighten the loop while positioning the buckle on the outside of the arm. As tension is applied to the sling, the loop

will tighten. To adjust the sling tension loosen the keeper and pull the lead end down toward the loop until the proper tension is obtained. This adjustment varies with each individual and position. Move the keeper toward the left arm and tighten it. Place the left hand over the sling and under the rifle, move it forward in the upper sling swivel so that the rifle rests in the "V" formed by the thumb and forefinger. After the proper sling tension has been determined for each position the firer should mark his sling for each adjustment.

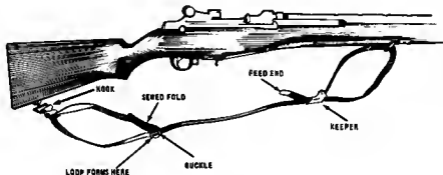

Figure 137. Web sling adjustment.

b. *Good Position.* The three elements of a good position are bone support, muscular relaxation, and a natural point of aim or an aiming point.

111 *Bone support.* Firing positions are designed as foundations for the rifle. It should be stressed that a good foundation for the rifle is important to good shooting. When a firer uses a weak foundation position for the rifle, without bone support, he will not be able to apply the fundamentals of shooting.

121 *Muscular relaxation.* The firer must learn to relax as much as possible in the various firing positions. Undue muscle strain or tension causes trembling which is transmitted to the rifle. However, in all positions a certain amount of controlled muscular tension is needed. Only through practice and achieving a natural point of aim will the firer learn muscular relaxation.

131 *Natural point of aim.* Since the rifle becomes an extension of the body, it is necessary to adjust the position until the rifle points naturally at the target. When the firer takes his position he

should close his eyes, relax, and then open his eyes. With proper sight alignment, the position of the front sight will indicate the natural point of aim. By moving his feet or body, and by breath control, the firer can shift the natural point of aim to the desired aiming point.

c. *Additional Positions.* In addition to the six firing positions discussed in paragraph 39 the variations of the sitting position and the squatting position can be of value. While not as steady as the prone position, they do enable the firer to fire across obstacles such as fallen timber and low walls.

111 *Open-leg (Fig. 138).* For the open-leg position, the sling is shortened about 5 to 7.5-CM (2 to 3 inches) from the prone position adjustment. The firer then lays half right from the target, crosses the left foot over the right foot, and sits down. He extends his legs a comfortable distance and spreads his feet approximately 90 cm (36 inches) apart. Bending forward at the waist, the sniper aligns his left upper arm over the left knee and down along the left shinbone. With the right

hand at the butt of the rifle, he pushes the rifle forward and places the butt into the right shoulder. He then moves the right hand forward, grasps the small of the stock, and lowers the upper arm until it rests inside the right knee. By pointing his toes inward, he prevents his knees from spreading and maintains pressure on his upper arms. The position is completed by relaxing the weight forward and assuming the correct stock weld.

(2) *Cross-leg (fig 139)*. The difference between the cross-leg and the open-leg positions is very slight. For the cross-leg position, the firer proceeds as for the open-leg position except that after sitting down he simply keeps his feet in place and positions his upper arms inside his knees. Many firers use the cross-leg position because it can be assumed quickly.

(3) *Cross-ankle (fig 140)*. For this position the firer crosses his ankles, sits down, and slides his feet forward. Bending at the waist, he places his upper arms inside his knees. As in the other positions, it is mandatory that adjustment of the natural point of aim be accomplished by body movement and not by muscle tension. In the sitting

position this is done by moving either foot, both feet, or the buttocks until the sights and target are aligned.

(4) *Supported sitting position (fig 141)*. The supported sitting position presumes that the firer is in an area or position where he can or must assume a modified sitting position to obtain a field of fire and observation into his target area. To assume the position he prepares a firing platform for his rifle or rests his rifle on the raised portion of his position. Caution must be exercised to insure that the barrel and operating parts do not touch the support. He then assumes a comfortable sitting position to the rear of the rifle, grips the small of the stock with his right hand, placing the butt of the rifle into his right shoulder; his left hand is on the small of the stock to assist in assuming a good stock weld and to acquire the proper eye relief. He then rests his elbows upon the inside of his knees similar to the standard cross-legged position. Adjustments to the position can be made by varying the position of the elbows on the inside of the knees or by varying the body position, as this position may be tiring.



Figure 138 Open-leg sitting position.



Figure 139 Cross-leg sitting position



Figure 140 Cross-ankle sitting position



Figure 131 Supported firing position

c **Squatting** The squatting position is a relatively steady position which can be assumed rapidly. Since only the feet touch the ground, it is an excellent position to use in mud, shallow water or a contaminated area. It is best suited for use on level ground or on ground that slopes gently downward. In assuming the squatting position, the firer faces the target and executes a half right face. He spreads his feet a comfortable distance apart and squats as low as possible. For maximum stability both feet should be flat on the ground. The left upper arm is placed firmly against the inside of the left knee, and the rifle butt is positioned in the pocket formed in the right shoulder. He grips the small of the stock with his right hand, lowers his elbow and blocks it against the inside of his right knee. The firer then obtains a spot weld.

d **Checklist** The following checklist is general in nature and with minor variations can be used to check each of the firing positions to insure that it adheres to the fundamentals.

(1) Rifle is vertical (optical sight horizontal crosshair is level)

(2) Left hand is forward to upper sling swivel (if possible)

(3) Rifle rests in the V formed by the left thumb and forefinger and is supported by the heel of the hand with fingers relaxed

(4) Left elbow is approximately under the trigger

(5) Sling is high on left arm

(6) Shoulders are approximately level to prevent the rifle from canting

(7) Butt of rifle is close to neck and positioned in the pocket of the shoulder

(8) Face is firmly fixed on the stock (stock web) with proper eye relief

(9) There is space between trigger finger and stock

(10) Trigger finger presses straight to the rear

3. **Position Training.** Position training should be conducted by experienced personnel. Each prospective firer will need individual attention when he is selecting and developing his positions. During initial position training, a tight sling is necessary in order to condition firer's muscles. Correct sling tension has been obtained when it becomes necessary for the firer, in placing the butt of his rifle into his shoulder to apply forward pressure on the butt with his right hand. After the firer has become accustomed to the positions, it may be necessary to adjust the sling in order to insure correct sling tension in each position. Use of the hinged butt plate, most firms find, eliminates any slipping of the butt in the shoulder, thereby adding support to the position and reducing the wobble area. Experience will develop the firer's prone position to a point where his wobble area will not be noticeable to him. Using the sling in conjunction with the supported or non-supported positions will add to the firer's ability to hold the weapon steady.

116. Trigger Control

1. The act of firing the rifle without disturbing the aim is considered the most important fundamental of shooting. Poor shooting is usually caused by disturbing the aim just before or as the bullet leaves the barrel and is the result of jerking the trigger or flinching. The trigger need not be jerked violently to spoil the aim; even a slight,

sudden pressure of the trigger finger is enough to cause the barrel to waver and spoil the sight alignment. Flinching is the involuntary movement of the body, tensing the muscles of the arm, the neck, and the shoulder in anticipation of the shock of recoil or the sound of the rifle firing. A firer can correct these errors by understanding and applying trigger control.

2. The slack or free play in the trigger is taken up first, and as resistance is met the firer perfects his aim while continuing the steadily increasing pressure until the hammer falls (fig 142). When done properly, the firer will not know the exact instant the rifle will fire. If he does not know the exact instant the rifle will fire, he will not anticipate the shock of recoil or the sound of the rifle firing.

3. Jerking the trigger, flinching, bucking, tensing of the facial and hand muscles, and closing the eyes when the shot is fired, indicate shot anticipation. By being convinced of these errors and conscientiously applying the correct trigger control, the firer will be able to overcome the tendency to anticipate the shot.

4. The technique of trigger control may vary slightly due to the instability of a position. If, while increasing his pressure, an error occurs in the sight alignment or sight picture, the firer holds that pressure he has on the trigger until the correct sight alignment or sight picture is reestablished; then he continues the pressure until the rifle fires (fig 143). Usually the result is a surprise shot that is good.

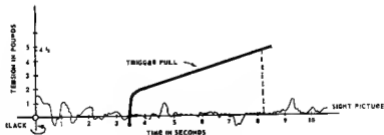

Figure 142. Smooth trigger pull.

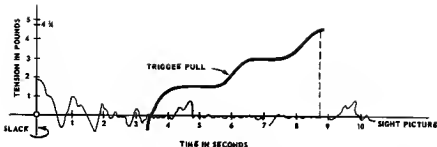

Figure 142. Interrupted trigger pull.

e. In all positions, one of the best methods of developing proper trigger control is through dry firing. In dry firing, not only is the coach able to detect errors, but the individual firer is able to detect his own errors since there is no recoil to conceal the rifle's undesirable movements. Where possible, trigger control practice should be incorporated in all phases of marksmanship training. The mastery of proper trigger control takes patience, hard work, concentration, and a great deal of self-discipline.

117. Sight Adjustment

When a shot or shot group is fired and is not in the desired location on the target, the sights must be moved in order to move the shot or shot group to the proper location. The sights on the M14 rifle have the following characteristics:

a. Each click of elevation or windage on the standard issue M14 rifle is worth approximately 1 minute of angle and moves the strike of the bullet 2.8 centimeters (approximately 1 inch) on the target for each 100 meters of range.

b. Each click of windage on the national match (M21) rifle will move the strike of the bullet 1.4 centimeters per 100 meters of range. (32 clicks to left or right of zero line), while the elevation is the same as for the standard issue rifle. If the rifle is equipped with a hooded rear sight aperture, it has a ½ minute elevation change capability. To move the strike of the bullet up one-half minute, the hood must be rotated so that the notch in the hood is up. If the notch in the hood is already up and a ½

minute increase in elevation is desired, the elevation knob must be moved up one click, and the hood rotated so the notch is down. The reverse procedure will move the sights downward.

c. Mechanical windage zero is determined by aligning the sight base index line and the center line of the windage gage. The location of the movable index line indicates the windage used or the windage zero of the rifle; e.g., if the index line is to the left of the center line of the gage, it is a left reading. Windage zero can be determined by simply counting the number of clicks back to the mechanical zero.

d. The elevation zero for any range is determined by counting the number of clicks down to mechanical elevation zero (hooded aperture notch down).

e. The sniper scope has an elevation and a windage turret assembly for making sight adjustments. Both are identical in appearance and movement. Each turret (fig 144) has a dial with an arrow indicating direction of movement; the elevation dial reads UP; the windage dial reads R for right. Both windage and elevation adjustments are graduated in ½ minutes of angle, shifting the strike of the round 1.4 cm for each 100 meters of range in the direction indicated by the arrow.

f. Sight adjustment is a very important aspect of training. A recommended exercise is the one-round sight drill. The firer fires three 3-round shot groups moving the sights in windage and/or elevation after each group fired, without removing the rifle from the shoulder between groups, if possible.

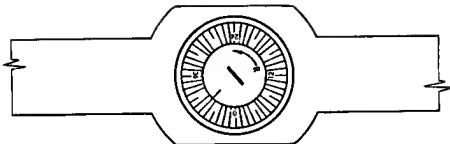

**WINDAGE SCALE - INTERNAL ADJUSTMENT
RIGHT SIDE**

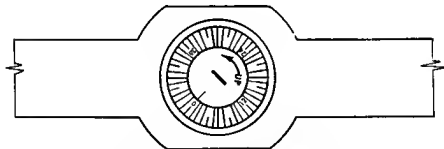

**ELEVATION SCALE - INTERNAL ADJUSTMENT.
TOP**

Figure 144. Turret assembly.

118. Effects of the Weather

In the case of the highly trained firer, effects of the weather are of primary importance because they can cause an error in the strike of the bullet. The wind, mirage, light, temperature, and humidity all have some effect on the bullet, the firer, or both.

a. Wind.

111 The condition which constantly presents the greatest problem to the firer is the wind. Wind has a considerable effect on the bullet. This effect increases with the range. This is due primarily to the increased time the bullet is exposed to the wind (due to its dropping velocity) per unit distance as the range increases. Wind also has a considerable effect on the firer. The stronger the wind, the more difficulty the firer has in holding the rifle steady. The effect on the firer can be partially offset with good training and conditioning.

121 Before any sight adjustment can be made to compensate for wind it is necessary to determine its direction and velocity. There are certain indicators which the firer may use to accomplish this. These are range flags, smoke, trees, grass, rain, and the sense of touch. Another important indicator, "mirage," will be discussed in a later paragraph.

(a) A common method of estimating the velocity of the wind (in training) is based on observation of the range flag. The angle in degrees between the flag and its pole is multiplied by the constant number .4 (or, the angle is multiplied by 4 and divided by 10). The result gives the approximate velocity in kilometers per hour (fig 145).

(b) If no flag is visible, a piece of paper, grass, cotton, or some other light material may be dropped from the shoulder. By pointing directly at the point where it lands, the approximate velocity in kilometers per hour (fig 146) is calculated.

(c) If for some reason these methods cannot be used, the following information is helpful in determining velocity: Under 5 kmph (kilometers per hour), wind can hardly be felt, but may be determined by smoke drift.

At 5—8 kmph, wind can just be felt on the face.

At 8—13 kmph, leaves in trees are in constant motion.

At 19—24 kmph, small trees begin to sway.

131 Since the firer must know how much effect the wind will have on the bullet, he must be able to classify the wind. The universally accepted method is by use of the clock system (fig 147). A half value wind will affect the strike of the bullet approximately one-half as much as full value wind of the same velocity. A wind velocity corrected in this manner is called the "effective wind." The so-called "no value" wind has a definite effect on the bullet at long ranges if it is not blowing directly from 6 to 12 o'clock. This is the most difficult wind to fire into due to the switching or "flattail" effect which requires frequent sight changes. Depending on the velocity, this type wind may have a slight effect on the vertical displacement of the bullet.

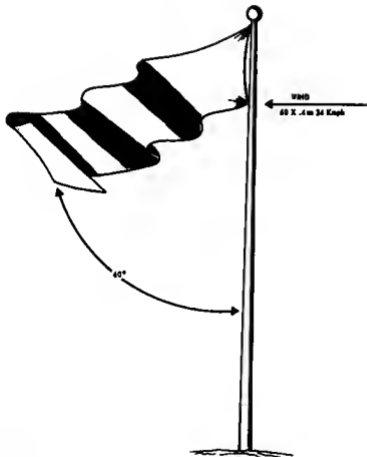

Figure 145. The flag method of wind estimation.

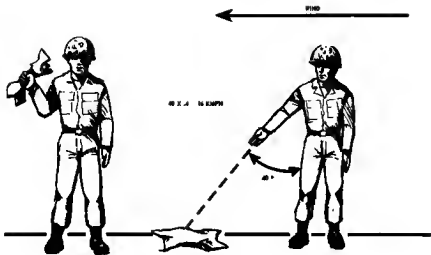

Figure 146. Wind estimation.

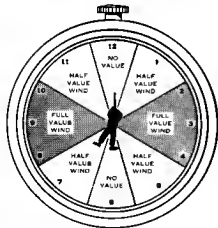

Figure 147. Clock system.

44) After determining wind direction and velocity, the windage correction to be placed on the sights will be based on the following formulas.

$\frac{R \times V}{15}$ = number of clicks for a full value wind on a national match (M21) rifle.

$\frac{R \times V}{25}$ = number of clicks for a full value wind on a standard issue rifle with standard ammunition.

In these formulas, R = range in hundreds of meters, V = velocity of the wind in kmph. For half value winds simply divide the answer by 2. The constants 15 and 25 were arrived at mathematically considering the bullet weight, density, velocity, air resistance, distance to target, and rear sight movement.

Example: The wind is blowing from 9 o'clock at 10 kmph. The range is 300 meters; using the wind formula, $R = 3$ and $V = 10$.

$$\frac{R \times V}{15} = \frac{3 \times 10}{15} = 2 \text{ clicks}$$

$$\frac{R \times V}{25} = \frac{3 \times 10}{25} = 1.2 \text{ clicks, rounded off to the nearest whole number} = 1 \text{ click.}$$

A graphic diagram for determining windage corrections is found in figura 148.

b. Mirage.

111 The word "mirage" refers to the heat waves or reflection of light through layers of air of different temperature and density as seen by the naked eye on a warm, bright day. With the telescope, a mirage can be seen on all but the

coldest days. Proper reading of mirages will enable the firer to estimate and make windage corrections with a high degree of accuracy.

121 As observed through the telescope, the mirage will appear to move with the same velocity as the effective wind, except when blowing straight into or away from the scope. Then the mirage will give the appearance of moving straight up with no lateral movement. This is termed a "Boiling" mirage. In general, changes in the velocity of the wind can readily be determined by observation of the mirage up to speeds of approximately 19 kmph. Beyond that speed, the movement of the mirage is too fast for detection of minor variations.

WINDAGE DIAGRAM

CIRCLES REPRESENT WIND VELOCITY IN KILOMETRES PER HOUR (kmph) AS INDICATED IN THE VERTICAL COLUMN.
 ROMAN NUMERALS INDICATE WIND DIRECTION.
 ARABIC NUMERALS INDICATE CLICKS OF WINDAGE.
 AS FOUND ON BEAR SIGHT OF M14 RIFLE.

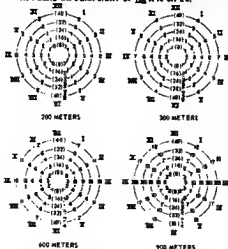

Figure 148. National match M14 windage diagram.

131 Figure 149 gives an illustration of the relative appearance of the mirage under varying velocities and directions. In general, the shallower the waves of the mirage the faster the wind speed.

141 The true direction of the wind may be determined by traversing the telescope until the heat waves move straight up without lateral motion is boiling mirage).

151 A mirage is particularly valuable in reading so-called "no value" winds. If the mirage is boiling, the effective wind velocity is zero. If there is any lateral movement of the mirage at ranges of 300 to 900 meters it is usually necessary to make a windage adjustment.

161 Another effect of mirage is the light refraction caused by the uneven air densities.

Depending on atmospheric conditions, this refraction will cause a displacement of the target image in the direction of the movement of the mirage. Thus, if a mirage is moving from left to right, the target will appear to be slightly to the right of its actual location. Since the firer can only aim at the image received by his eye, he will actually aim at a point which is offset slightly from the center of the target. This error will be small compared to the displacement of the bullet caused

by the wind, but will have to be taken into account even on windless days since a boiling mirage may cause a vertical displacement of the target. Since the total effect of the visible mirage (effective wind plus target displacement) will vary considerably with atmospheric conditions and light intensity, it is impossible to predict the amount of error produced at any given place and time. It is only through considerable experience in reading mirage that the firer will develop proficiency as a "wind doper."

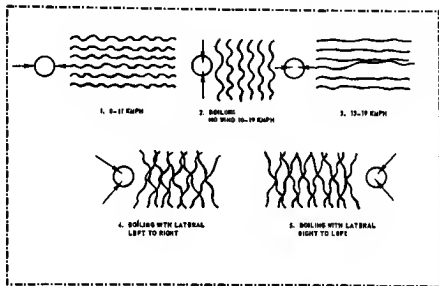

Figure 149. Types of mirage.

(7) In utilizing the telescope to read the mirage the following adjustment technique is used: Pick out an object midway to the target and adjust and focus the scope at that point. Without disturbing the focus, adjust the scope onto the target. Since the scope is focused to read the mirage, the target will appear fuzzy.

c. **Temperature.** Temperature has a definite effect on the elevation setting required to hit the center of the target. This is caused by the fact that an increase in temperature of 11° centigrade will increase the muzzle velocity by approximately 15 meters per second. Figure 150 illustrates the temperature effect on the velocity of match ammunition. Regardless of the range, the firer must

change his sights 1 minute for each 11 degree change in temperature. For a drop in temperature the sights must be raised; for an increase in temperature the sights must be lowered.

d. **Light.** Light may or may not have an effect on the firer's aim. It affects different people in different ways. The general tendency, however, is for the firer to shoot high on a dull, cloudy day and low on a bright, clear day. Extreme light conditions from the left or the right may have an effect on the horizontal impact of a shot group. To solve the problem of light and its effects, the individual firer must accurately record the light conditions under which he is shooting. Through experience and study he will eventually determine the effect of light on his aim.

a. *Humidity.* An increase in humidity decreases the density of the air and therefore decreases the air resistance. The effect, however, is very small and can be neglected for rifle fire at all practical ranges.

f. *Extrinsic Ballistics.* Although extensive ballistics tables are not required by the firer, it is of value for him to understand how and to what degree various factors affect the trajectory and velocity of the projectile.

TEMPERATURE EFFECT ON VELOCITY
7.62 L6 MATCH AMMUNITION

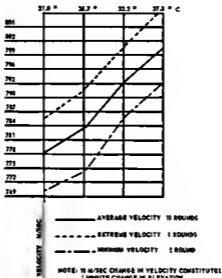

Figure 150. Temperature effects.

111 In the following table curve A represents those factors (high temperature, low barometric pressure, and high relative humidity) which foster a high bullet velocity. The factors in curve B produce low bullet velocities, and curve C represents more average conditions. Greater extremes can, of course, be encountered resulting in correspondingly greater deviation.

(21 Chart 3 (fig 151) defines the three curves in terms of their variables and shows the relationship of bullet velocity to range. Charts 4 and 5 (figs 152, 153) show the time of bullet travel versus range and bullet drop versus the range respectively.

(31 These tables are valid only for the 7.62-mm. M118 match cartridge.

119. Zeroing and Use of the Record Data Sheet

The way to zero a rifle is to shoot it in the position,

range, and cadence at which it is intended to be used. Since obtaining a correct zero is so important, this exercise has been included. Depending upon the situation, a firer could be called upon to deliver a single, accurate shot at any range up to 900 meters. The firer must zero whenever he receives a different weapon, a new lot of ammunition, or when his rifle is disassembled for any reason. Prior to zeroing, 10 rounds should be fired to insure complete settling of the receiver into the stock. A rifle must be zeroed by the individual who intends to use it. Characteristics such as spot weld, eye relief, position, and trigger control usually result in a different zero for different individuals with the same weapon. For the same reason, an individual's zero may change from one position to another when firing at the same range.

a. Zeroing with Iron Sights.

(11 *Measured distance.* The most precise method of zeroing a rifle is to place distinctive

aiming points at known distances. Place the targets between 100 and 900 meters in 100-meter increments. The firer then fires one or more three-round shot groups at each aiming point adjusting the rear sight until the center of the shot group and the aiming point coincide at each range. The firer should zero first at the shortest range, and then at

each succeeding range. The firer's initial zeroing for each range should be accomplished from his most stable position. He should then zero from those positions and ranges that are most practical. There is no need to zero from the least steady positions at the longer ranges.

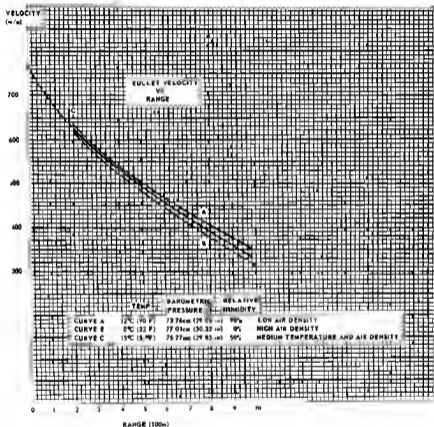

Figure 151. Chart 3, bullet velocity versus range.

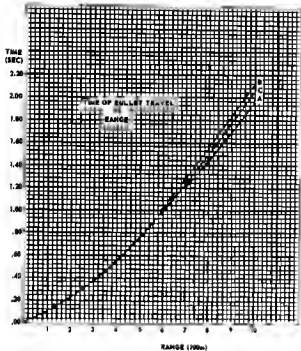

Figure 152. Chart 4, time of bullet travel versus range.

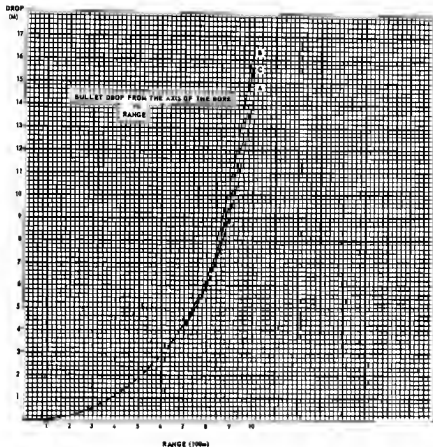

Figure 153. Chart 5, bullet drop versus range.

121 *Field expedient.* This method may be used when the time or the situation does not permit the use of the known distance. It is mostly used for confirming old zeroes. The firer will require an observer equipped with binoculars or a spotter telescope to assist him. The firer and observer pick out an aiming point in the center of an area—hillside, brick house, or any surface where the strike of the bullet can be observed. The range to this point can be determined by map survey, the range card of another weapon, or by ground measurement. Once the firer has assumed a stable

position, the observer must position himself to the rear of, but close to, the firer. The observer's binoculars or telescope should be positioned approximately 47 to 60 centimeters (18 to 24 inches) above the weapon and directly in line with the axis of the bore. Positioning his optics in this manner enables the observer to see the trace of the bullet as it moves down range. The tracer or shock wave of the bullet sets up an air turbulence sufficient enough to be observed in the form of a vapor trail. The trace of the bullet enables the observer to follow the path of the bullet in its trajectory toward

its impact area. The trace will disappear prior to impact making it appear to the inexperienced observer that it struck above or beyond its actual impact point. For example, at 300 meters the trace will disappear approximately 15 centimeters above its impact point. At 500 meters the trace will disappear approximately 63 centimeters above its impact point. Wind causes lateral movement of the bullet. This lateral movement will appear as a drifting or bending of the trace in the direction that the wind is blowing and must be considered when determining windage zero. The observer must be careful to observe the trace at its head and not be misled by the bending tail of the trace in a strong cross wind. Prior to firing the first round, the firer must set his sights so that he will hit on or near his aiming point. This sight setting is based on the old zero or an educated guess. The firer fires a shot and gives a call to the observer. If the strike of the bullet could not be observed, the observer gives a sight adjustment based on the trace of the bullet. Once the strike of the bullet can be observed in the desired impact area, the observer compares the strike with the call and gives sight adjustments until the bullet impact coincides with the aiming point.

b. Confirming Zero. Once a rifle has been zeroed, and it becomes necessary to confirm this zero for any reason, it can be zeroed again by firing at a known distance with the sights set on the old zero. If a sight adjustment is necessary to hit the aiming point, this zero change will remain constant at all ranges. For example, if firing at a distance of 500 meters with the old zero and it becomes necessary to raise the elevation 3 clicks to hit the aiming point, the elevation zero should be raised 3 clicks at all ranges.

c. Zeroing the Sniper Rifle Using the Scope Sight. The most precise method of zeroing the sniper rifle, utilizing the scope sight, is to fire and adjust the sight to hit a given point at 300 meters. The following zeroing procedure should be utilized:

- 1) Properly mount the scope on the rifle.
- 2) Select or prepare a distinct target (aiming cross) at 300 meters (fig 154).
- 3) Assume the supported prone position.
- 4) Loosen the power ring lock by turning the knurled nut counterclockwise.
- 5) Turn the power adjustment ring to the low power range setting (3 index).

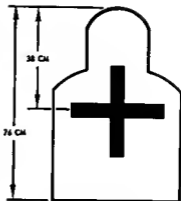

Figure 154. Prepared aiming target.

16) While aiming, superimpose the crosshair over the aiming cross and position the 76-cm 134 inf target between the vertical stadia marks.

17) Fire a 3-round group and determine its location and distance from the aiming cross.

18) Utilizing the elevation and windage rule determine the number of clicks ($\frac{1}{2}$ minutes) of elevation and windage necessary to move the center of the group to the center of the aiming cross.

19) Remove the elevation and windage turret caps and make the necessary sight adjustments. In making sight adjustments, remember to turn the adjusting screws in the direction you wish to move the strike of the bullet or group.

110) Fire additional groups as necessary in order that the center of the shot group coincides with the point of aim at 300 meters.

111) Zero the elevation and windage scales and replace the turret caps.

112) The rifle is now zeroed for 300 meters.

113) To engage targets at other ranges the firer need only set the desired range (300 to 900 meters, inscribed on the focusing ring) opposite the reference dot on the top of the scope. To engage targets at undetermined ranges the firer ranges on the target, in conjunction with ranging, elevation is

imperted to the scope by the ballistic cam; this compensates for trajectory.

Note. Do not move the elevation and windage adjusting screws beyond the point where reticle movement stops. The mechanism may become disengaged and require factory repair.

(14) The ballistic cam principle of the sight eliminates the necessity to adjust the sights manually for each range, or to record zero settings. However, for ease of correction, to facilitate minor changes in elevation or windage, or to indicate a mechanical zero for the 300-meter zeroing range, the elevation and windage scales should be zeroed once the 300-meter zero is established. This is accomplished by rotating the movable index scale until the 0 is aligned with the adjusting screw index line.

d. Firing at Targets for Which No Definite Zero Has Been Established. When firing on targets at a range of 100 meters or less, the 100-meter zero should be used. The difference between the impact of the bullet and the aiming point is negligible. The difference between the impact of the bullet and the aiming point increases as the range increases, if the sights are not moved. If a firer's zero is 46 clicks at 900 meters and 40 clicks at 800 meters, and if he estimates the range of a target at 850 meters, he should use a sight setting of 43 clicks rather than using his 800- or 900-meter zero or the adjusted aiming point method. At any range, moving the sights is preferred over the adjusted aiming point method.

a. Range Estimation Using Telescopic Sight. The optical sight has one set of vertical and one set of horizontal stadia lines. When used at a range in hundreds of meters corresponding to the power setting, the stadia lines on the vertical crosshair measure a height of 76 cm (30 in) and the film on the horizontal crosshair a width of 152 cm (60 in). To utilize the stadia lines the firer determines a 76 cm high target (approximately the distance from a man's groin to the top of his head) and adjusts the power ring on the scope until the stadia lines just bracket the target (fig 134). The ballistic cam of the scope will simultaneously adjust for the range and the firer is ready to engage the target.

f. Use of Record Data Sheet.

(11) During the zeroing period there are several items of information to be recorded by the firer. Included in this recorded data is a record of each shot or shot group fired, and the weather conditions and their effects on the strike of the bullet and the firer. If used properly it will provide the necessary information for initial sight settings at each distance or range. It provides a basis of analyzing the performance of the firer and his rifle, and it is a valuable aid in making bold and accurate sight changes.

(12) A sample record data sheet is pictured in figure 155. This sample record data sheet or something similar can be made by the individual on mimeographed. This sheet, when properly maintained, will give the firer, or instructor, a complete picture of the firm's performance and zero under varying weather conditions. The individual firer should use a new record data sheet for each different weapon and include data on the place, ammunition lot, firing position, distance, and weather conditions.

(13) Instructions in the use of the record data sheet should be given prior to zeroing. The following procedure should be used for filling out and maintaining the record data sheet. This sheet is maintained in three phases: before firing, during firing, and after firing.

(a) Before firing.

Place: Name of range or location.

Date:

Hour:

Rifle No:

Ammunition: Type and lot number.

Temperature:

Position: Firing position used.

Distance: Range to target in meters.

Elevation: Elevation in minutes to be used for initial shot (with the hooded aperture in the up position add $\frac{1}{2}$).

(b) During firing.

Call: Place a dot in the call block where that shot is expected to hit. If excessive movement is seen as the rifle fires, indicate the direction of movement with an arrow in the call block.

Hit: Plot location of shot group by number in target after shot or group is marked.

ELEV ZERO 23	WINDAGE ZERO IR	PLACE F73K	DATE 17 JUN 66	HOUR 0800												
		RIFLE NO. 946771	WIND Gusty	AKKO 44/2015												
		<table border="1"> <tr> <td>WIND</td> <td>SIGHT PICTURE</td> <td>LIGHT</td> <td>TEMP 15C°</td> </tr> <tr> <td></td> <td></td> <td></td> <td>LIGHT BRIGHT</td> </tr> <tr> <td>EMPH 8</td> <td></td> <td>DIRECTION</td> <td>MIRAGE SLIGHT</td> </tr> </table>	WIND	SIGHT PICTURE	LIGHT	TEMP 15C°				LIGHT BRIGHT	EMPH 8		DIRECTION	MIRAGE SLIGHT		
		WIND	SIGHT PICTURE	LIGHT	TEMP 15C°											
					LIGHT BRIGHT											
EMPH 8		DIRECTION	MIRAGE SLIGHT													
SHOT NO.	1	2	3	4	5	6	7	REMARKS								
ELEV	22	24				25		Did not estimate wind corrected by on the first shot.								
W. G.	2L	3L														
CALL																
SHOT NO.	8	9	10	11	12	13	14									
ELEV																
W. G.								POSITION PRONE								
CALL								DISTANCE 500								

Figure 155. Simple record data sheet

Elevation: Enter any elevation change applied to the rifle under that numbered shot.

Windage: Enter any windage used (in clicks) under that numbered shot. Count left or right from actual zero not mechanical zero.

(c) After firing.

Wind: Word description (steady, gusty, fluctuating).

Light: Word description (bright, dull, hazy, overcast).

Mirage: Word description (medium, heavy) and/or a simple picture (fig 149).

Windage diagram: Velocity in kmph and show direction with an arrow.

Light diagram: Show direction with an arrow (arrow should point in direction the firer's shadow is cast when he is facing the target).

Sight picture: Show the position of the front sight in relation to target for that group of shots.

Remarks: Make a note of any equipment, performance, weather conditions, or range conditions that had a good or bad effect on the firing results.

Elevation zero: That elevation in minutes that is correct for this position and distance.

Windage Zero: The number of clicks left or right of mechanical zero that is correct under no wind conditions for this position and range.

14) The record data sheet should be analyzed by the individual at the completion of firing from

each position and range and again at the end of each day's firing. Some of the things to look for when analyzing the data sheet are:

(a) Compare hits to calls: if they agree it's a good indication that zero is correct and any compensation for the effects of weather was correct. If the calls and hits are consistently out of the target, sight adjustment or more position and trigger control work are necessary. Comparisons of the weather condition and location of the groups on the latest data sheet with previous data sheets aid in determining how much and in which direction the sights should be moved to compensate for the various weather conditions. If better results are obtained with a different sight picture under an unusual light condition, then the firer should use this sight picture whenever firing under that particular light condition. A different sight picture may necessitate adjusting the sights. After establishing how much to compensate for the effects of weather, or which sight picture works best under various light conditions, the firer should commit this information to memory.

(b) The firing data sheets used for training or zeroing should be kept for future reference. Rather than carry the firing data sheets during training, exercise, or combat, a list of the elevation and windage zeros at various ranges can be carried by the individual in his pocket or taped on the weapon stock.

Section iii. DETECTION AND CORRECTION OF ERRORS

126. General

Sometimes errors are not readily evident, and this is when a good instructor will be of great value. It is necessary to isolate the error(s), prove to the firer that he is making this error(s), and convince him that through his own efforts and concentration he can correct his error(s). Knowing what to look for

through analysis of the shot groups, observation of the firer, questioning the firer, and reviewing the fundamentals or training exercises will assist the instructor in this process.

a. *Target Analysis* (fig 156). Target analysis is an important step in the process of detection and correction of errors.

①



GROUP STRUNG LOW AND RIGHT
POSSIBLE CAUSES

- A IMPROPER TRIGGER CONTROL
- B PRONE POSITION LEFT ELBOW NOT POSITIONED CORRECTLY ON THE RIGHT ELBOW SLIPPING
- C SITTING POSITION RIGHT ELBOW SLIPPING OR LEFT ELBOW SLIPPING DOWN THE LEFT LEG

②



GROUP SCATTERED ABOUT SILHOUTTE
POSSIBLE CAUSES

- A IMPROPER TRIGGER
- B INCORRECT SIGHT ALIGNMENT OR PICTURE
- C EYE NOT FOCUSED ON THE FRONT SIGHT
- D CHANGING THE SPOT-WELD
- E LOOSE POSITION

③



GROUP WITH SEVERAL ERRATIC SHOTS
POSSIBLE CAUSES

- A FLINCHING SHOTS MAY BE ANYWHERE
- B SUCCESSIVE SHOTS FROM SEVEN TO TEN O'CLOCK
- C JERKING SHOTS MAY BE ANYWHERE

④



GROUP STRUNG UP DOWN THROUGH SILHOUTTE
POSSIBLE CAUSES

- A BREATHING WHILE FIRING
- B IMPROPER VERTICAL ALIGNMENT OF SIGHTS
- C CHANGING THE SPOT WELD

⑤



COMPACT GROUP ON EDGE OR OUT OF SILHOUTTE
POSSIBLE CAUSE

- A INCORRECT ZERO
- B FAILURE TO COMPENSATE FOR WIND
- C POSITION NATURAL POINT OF AIM OFF

⑥



GROUP FROM CENTRE TOO STRUNG OUT OF BOTTOM OF SILHOUTTE
POSSIBLE CAUSES

- A LOOSE REAR SIGHT
- B SLING SLIDING DOWN ARM
- C TOO LOW POSITION
- D CHANGING POSITION OF SIPLE IN SHOULDER AFTER BELD

⑦



HORIZONTAL GROUP
POSSIBLE CAUSES

- A INCORRECT SIGHT ALIGNMENT
- B CARRYING THE WEAPON WHILE FIRING
- C LOOSE FRONT SIGHT
- D LOOSE POSITION
- E MUSCLING SIPLE

Figure 156. Target silhouette analysis.

When analyzing a target, the instructor critiques and correlates errors in performance to loose groups, shape of groups, and size of groups. Seldom is a bad shot group caused by only one error.

b. *Observation of the Firer.* When the instructor has an indication that a firer is committing one or more errors, it will usually be necessary for the instructor to observe this firer while he is in the act of shooting in order to pinpoint his error(s). If the instructor has no indication of the firer's probable errors, the initial observation should be on the individual's firing position and breath control. Next, he observes for the most common errors— anticipation of the shot and improper trigger control.

c. *Questioning the Firer.* The firer should be asked if he can detect his error(s) and to explain his

firing procedure to include position, aiming, breath control, trigger control, and followthrough.

d. *Training Exercises.* These training exercises or devices can be used at anytime to supplement the detection procedure.

- (1) Trigger exercise.
- (2) Metal disk exercise.
- (3) Ball and dummy exercise.
- (4) Blank target firing exercise.
- (5) M2 aiming device.

121. Detection and Correction of Errors Checklist

This checklist can be used by the instructor to determine shooting errors (fig. 157).

ERROR	TARGET ANALYSIS	OBSERVATION AND DETERMINING	FORMS OR CORRECTING DEVICES
SHOT ALIGNMENT	VERTICAL, HORIZONTAL, OR SCATTERED NOT A GROUP	ABILITY TO CALL SHOT AT AIMING DEVICE, FIRER EXPLAIN.	BLANK TARGET FIRING AIMER BAR IN SIGHTING DEVICE
SHOT PICTURE	VERTICAL, HORIZONTAL, SCATTERED OR MISPLACED NOT A GROUP	ABILITY TO CALL SHOT AT AIMING DEVICE, FIRER EXPLAIN.	BLANK TARGET FIRING AIMER BAR IN SIGHTING DEVICE
EYE FOCUSED ON TARGET	SCATTERED OR MISPLACED NOT A GROUP	ABILITY TO CALL SHOT FIRER EXPLAIN.	BLANK TARGET FIRING NOT FIRING
BREATHING	VERTICAL SHOT GROUP	OBSERVE FIRER'S FACE IN AIMING DEVICE, FIRER EXPLAIN.	DOT FIRING
EYE RELIEF	SCATTERED GROUP	OBSERVE FOR INCONSISTENT SMOKE/TWICE HOLD	DOT FIRING
INDIRECT SHOT SETTING	MISPLACED SHOT GROUP	CALL SHOTS CHECK FOR LOOSE SHOTS	TRIFT ZERO COMPENSATE FOR THE EFFECTS OF WEATHER
POSTAL POSITION	SCATTERED SHOT GROUP	OBSERVE FOR BUTT PLATE, LEFT OR RIGHT SLING, SLIPPING, INABILITY TO RECOVER, VERTICAL OR HORIZONTAL OR MISPLACED BREATHING	GRAPED SLING TENSION SHORTLY POSITION DOT FIRE
LATERAL POINT OR AIM	MISPLACED SHOT GROUP	EXCESSIVE MUSCLE TENSION	TALK FIRER THROUGH THE PROCESS OF ADJUSTING RAYTRAL POINT OR AIM
DEVICEMATHS THE SHOT	SCATTERED GROUP, FLINCH DOES ANYTHING, SHOCK DOES LEFT, JERK DOES SHOT, FLIP OF LEFT HAND DOES FROM LEFT, RELAXATION OR TENSION EITHER HAND DOES LEFT OR RIGHT	SHOOTS FOR A MUSCLE SPASM OR TENSION OR HARD OR FACIAL MUSCLES OR NOT FOLLOWING THROUGH	BALL AND DUMMY DOT FIRING BLANK TARGET FIRING METAL DISK EXERCISE TRIGGER EXERCISE

Figure 157. Error checklist.

APPENDIX A

REFERENCES

- AR 350-4 Qualification and Familiarization with Weapons and Weapon Systems.
AR 385-63 Regulations for Firing Ammunition for Training, Target Practice, and
 Combat.
- FM 5-20 Camouflage.
FM 21-5 Military Training Management.
FM 21-6 Techniques of Military Instruction.
FM 21-40 Chemical, Biological, Radiological, and Nuclear Defense.
FM 21-75 Combat Training of the Individual Soldier and Patrolling.
TC 23-11 Starlight Scope, Small Hand-held or Individual Mounted, Model No.
 6060.
TC 23-14 Sniper Training and Employment.
TM 3-220 Chemical, Biological, and Radiological (CBR) Decontamination.
TM 9-1005-223-20 Organizational Maintenance Manual Including Basic Issue Items List
 and Organizational Repair Parts and Special Tools List: Rifle, 7.62-
 mm, M14 and M14A1, and Bipod Rifle, M2.
TM 9-1005-223-34 Direct Support, and General Support Maintenance Manual Including
 Repair Parts and Special Tools List: (Including Depot Maintenance
 and Repair Parts and Special Tools) Rifle, 7.62-mm: M14, M14A1,
 and Bipod Rifle, M2.
TM 9-1305-200 Small Arms Ammunition.
TM 9-6920-210-14 Operator, Organizational, DS and OS Maintenance Manual Including
 Basic Issue Items List and Repair Parts List: Small Arms Targets
 and Target Material.
TF 9-2970 US Rifle, 7.62-mm, M14, Operation and Cycle of Functioning (26
 min).
- ASubjSed 23-16 Sniper Training.
ASubjSed 23-71 Combat Marksmanship Proficiency Course.
ASubjSed 23-72 M16A1 Rifle Marksmanship.

METRIC CONVERSION TABLES

1. General

Metric units are based on the decimal system and for that reason are easier to manipulate than units in the English system. Additionally, units of dif-

ferent types, i.e., weight and length, use the same prefixes to establish their relationship to the basic unit.

a. Metric Prefixes.

(1) Mega-	one million	1,000,000
(2) Kilo-	one thousand	1,000
(3) Hecto-	one hundred	100
(4) Deca-	ten	10
(5) Deci-	one tenth	.1
(6) Centri-	one hundredth	.01
(7) Milli-	one thousandth	.001
(8) Micro-	one millionth	.000001

b. Units of Measure.

(1) Linear measure.

Basic unit is the meter (m).

1,000 m = 1 kilometer (km)

1,000 millimeter (mm) = 1 m

100 centimeter (cm) = 1 m

(2) Weight. Basic unit is the gram (g).

1,000 g = 1 kilogram (kg)

1,000 milligram (mg) = 1 g

(3) Velocity. Kilometers per hour (kmph) and meters per second (m/s).

1 m/s = 3.6 kmph

1 kmph = .28 m/s

(4) Temperature. Temperature is measured in degree centigrade.

c. *Common Usage.* Although all of the prefixes mentioned in a above can be used with such different type of unit, only a few of them are commonly used.

(1) In length measurements the meter, kilometer, centimeter, and millimeter are com-

a. Linear Measure.

1 m = 39.37 in

1 m = 3.28 ft

1 m = 1.09 yd

1 km = .62 mi

b. Weight.

1 g = 15.43 grain

1 g = .035 oz

1 kg = 35.27 oz

1 kg = 2.20 lbs

c. Velocity.

1 m/mc = 3.28 ft/sec

1 m/mc = 2.24 mph

1 kmph = .62 mph

monly used. Range-to-target distances are generally given in meters, longer distances in kilometers. Millimeters are frequently used to designate the caliber of a weapon. Because the units all differ by a multiple of ten, they can readily be interchanged and the choice of unit is frequently one of convenience.

(2) Both the gram and kilogram are often used. Again, the choice is one of convenience.

(3) Kilometers per hour are used for slow speed measurements, i.e. speed of vehicles, troops, and aircraft. Meters per second is used for faster speeds like the velocity of projectiles.

(4) Zero degree centigrade (0°C) is the freezing point of water and one hundred degree centigrade (100°C) is the boiling point. The metric prefixes in a above are not used with temperature measurements.

2. Conversion Tables

1 in = 2.54 cm
1 ft = 30.48 cm
1 yd = 91.44 cm
1 mi = 1609.34 m

1 grain = .0640 g
1 grain = 64.8 mg
1 oz = 28.35 g
1 lb = 453.59 g

1 ft/sec = .305 m/sec
1 ft/sec = 1.10 kmph
1 mph = 1.61 kmph

d. Temperature.

$$(1) 1^{\circ} \text{C} = 1.8^{\circ} \text{F} \quad 1^{\circ} \text{F} = .555^{\circ} \text{C}$$

Water freezing point $0^{\circ} \text{C} = 32^{\circ} \text{F}$

Boiling point $100^{\circ} \text{C} = 212^{\circ} \text{F}$

Common

temperatures $20^{\circ} \text{C} = 68^{\circ} \text{F}$

$$25^{\circ} \text{C} = 77^{\circ} \text{F}$$

$$30^{\circ} \text{C} = 86^{\circ} \text{F}$$

$$35^{\circ} \text{C} = 95^{\circ} \text{F}$$

(2) When converting degrees centigrade and degrees Fahrenheit, the different starting points of the two scales must be taken into consideration. The following conversion formulas make allowance for that.

$$^{\circ} \text{C} = 5/9 (^{\circ} \text{F} - 32)$$

$$^{\circ} \text{F} = 9/5 (^{\circ} \text{C}) + 32$$

(a) For example, to convert 77°F to centigrade:

$$^{\circ} \text{C} = 5/9 (77 - 32)$$

$$^{\circ} \text{C} = 5/9 (45)$$

$$^{\circ} \text{C} = 25$$

(b) To convert 20°C to Fahrenheit:

$$^{\circ} \text{F} = 9/5 (20) + 32$$

$$^{\circ} \text{F} = 36 + 32$$

$$^{\circ} \text{F} = 68$$

APPENDIX C

KNOWN DISTANCE FIRING

1. Purpose

Known distance firing gives the rifleman an opportunity to apply all the principles learned during preparatory marksmanship training. It is not a substitute for the standard rifle marksmanship program; it has been added for use by those units that desire additional rifle training for their personnel. The rifleman learns to zero his rifle for all usable ranges and to make practical application of sight adjustments. It instills confidence in him and requires him to fire accurately in order to become an effective rifleman. Known distance firing consists of instruction firing on the 25-meter range and on the known distance range.

2. Organization for Firing

a. A known distance range must be thoroughly organized to insure safe and efficient operation. A

suggested organization for known distance instruction firing is shown in figure 158. It may be modified to fit local range facilities. A 70-point known distance range can adequately handle a company of 200 men organized into three orders with another unit furnishing pit details. If it is necessary for a company to furnish its own details, a range with 50 firing points is adequate with the company organized into four orders. The waiting period associated with four orders or less is used for the fire to rest and prepare for the next exercise. However, if it is necessary for a unit to use five or more orders, some type of concurrent training should be conducted to profitable utilize waiting periods.

b. The following personnel are recommended for efficient operation of the range:

- (1) One range officer.

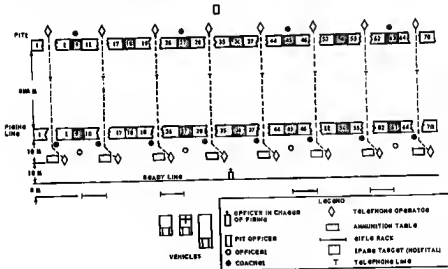

Figure 158. Known distance range construction.

- (2) One officer in charge of pits.
 (3) One safety officer to supervise two blocks of eight firing points each.

- (4) Assistant instructors.
 (5) One noncommissioned officer to supervise two blocks of eight targets each in the pits.

16) Two telephone operators for each block of eight targets lone on the firing line and one in the pits.

17) An ammunition detail as required.

18) Three target operators per targets. (One operator per target can be used, but having an extra man per two targets will permit the operators to take breaks without interfering with the conduct of the firing.)

c. The "A" target [FSN 6920-900-8204] is used for ranges from 100 to 300 meters, and the "B" target [FSN 6920-900-8205] is used for a range of 500 meters.

3. Conduct of Firing (General)

a. Commands for conduct of firing should be kept to a minimum and should be standardized. The proper commands are listed in the following paragraphs. In addition, preliminary commands to describe the particular exercise may be used.

b. The range officer should insure that his commands are relayed to the pit officer so that he can keep abreast of the firing being conducted. This may be done by public address system or by telephone. Before each firing exercise, the range officer should inform the pit officer what the next exercise will be, and give him any special instructions for target operation; for example, "The next firing will be for zero. Mark targets after each shot." Or, for the slow fire, he may say, "The next firing will be eight rounds, slow fire. Mark targets after each shot."

c. Telephone operators are used to relay commands to the pits as necessary and to pass on special instructions to target operators as requested by the assistant instructors. They should be informed that at no time are they to make known the identity of a firer on a particular firing point. The following commands are those normally required to be relayed to the pits:

(1) MARK TARGET NUMBER _____

(This indicates that the target has been fired upon, but has not been withdrawn for marking.)

(2) DISK TARGET NUMBER _____

(This indicates that the target has been withdrawn and a spotter placed in the pit, but the appropriate disk has not been used to show the value of the hit.)

(3) RE-DISK TARGET NUMBER _____

(This indicates that the target was disked, but the value was not observed or understood by the firer.)

4. Firing Commands

a. The following commands are general in nature and are to be stated where necessary.

FIRERS, ASSUME THE _____ POSITION.

ASSISTANTS, SECURE _____ ROUNDS OF AMMUNITION.

LOCK; ONE ROUND, LOAD.

READY ON THE RIGHT?

READY ON THE LEFT?

READY ON THE FIRING LINE?

COMMENCE FIRING WHEN YOUR

TARGET APPEARS.

CEASE FIRING.

b. The following commands should be used for rapid fire exercises:

FIRERS, ASSUME THE _____ POSITION.

RISE, KEEPING YOUR FEET IN PLACE.

ASSISTANTS, SECURE TWO MAGA-

ZINES OF FIVE ROUNDS EACH.

LOCK, ONE MAGAZINE, LOAD.

READY ON THE RIGHT?

READY ON THE LEFT?

READY ON THE FIRING LINE?

WATCH YOUR TARGETS!

(Firers commence firing when the targets are presented.)

c. Once all the targets are withdrawn, the range officer checks for alibis and then allows them to fire. An alibi is allowed when there is a malfunction NOT DUE TO THE FAULT OF THE FIRER.

5. Pit Operation

a. *General.* The pit officer is responsible for the organization, orientation, and safety of the pit detail. The success of known distance firing depends largely upon the efficient operation of the targets and the close coordination maintained between the pit officer and the range officer. All operators must be familiar with the proper procedure for operating and marking the target.

b. *Marking Targets for Zeroing and Slow Fire.* Targets are marked after each shot, without command, and as quickly as possible. During slow fire, the firer has a time limit of 1 minute for each shot. Twenty seconds is considered the maximum time limit for marking. A marker, or spotter, is placed in the pit regardless of its location on the target and then the value is indicated by the appropriate disk. Each time the target is marked, the marker is removed from the previous hit and the hole is pasted. (Three-inch markers are used for 100, 200, and 300 meters; 5-inch markers are used for 500 meters.)

c. *Operation and Marking Targets for Rapid Fire.* Targets are operated on order of the pit officer during rapid fire exercises. When the pit officer receives word that the firing line is ready he has a centrally located red flag waved three times and then withdrawn. Three seconds later he commands TARGETS UP or uses a prearranged, whistle or hand signal. He starts timing the exercise when the targets are fully raised. At the end of 50 seconds he gives the signal to lower all targets. Individual targets are then raised for alibi or refires, based on information received from the firing line. Next, the pit officer has the targets

marked. Markers are placed in each hit if the group is large. If the group is small, only enough markers are placed to indicate its location to the firer.

d. *Dishing the Targets.* Each hit is dished, starting with the highest value, and the pit officer has the targets posted after making sure that all firers have received their scores. The value of each hit or miss is indicated as follows:

10 Hold white paddle in front of black.

9 Hold red paddle in front of black.

8.5 Hold red paddle over appropriate number box on the target.

MISS Red paddle moved once across target from right to left.

a. *Paddle and Disk Markers.*

(1) The paddle marker (1 fig 159) may be constructed locally. The handle is approximately 3 meters (9 feet) long. The disk attached to one end of the handle is either 25 cm (10 in) or 50 cm (20

in) in diameter and is cut from sheet metal. One side of the disk is painted white, the other side is painted red.

(2) The target marking disk (2, fig 159) is painted black on one side and white on the opposite side. It may be procured in two dimensions: 7.5 cm (3 in) (FSN 6920-713-8255) and 12.5 cm (5 in) (FSN 6920-713-8254). The disk spindle may also be procured through supply channels (FSN 6920-713-8257).

Note. If a hit touches a line, it is given the value of the higher adjacent scoring ring.

6. *Regulations for Known Distance Instruction Firing*

The following regulations govern the conduct of known distance firing.

a. All shots fired on the wrong targets are recorded as misses in both slow and rapid fire.

b. During slow fire, if a target shows two hits, the following rules govern:



①



②



Figure 159.—Target paddle and disk markers.

(1) If the hits have the same value, both hits are spotted but only one is dished.

(2) If the hits have different values, both are spotted and the one with the highest value is dished.

c. During rapid fire, if more than ten hits appear on a target, the following rules govern:

(1) If all hits are of equal value the firer receives credit for the value of ten rounds, providing he fired the required number of rounds.

(2) If the hits are not of equal value and the individual fired the required number of rounds, he has the option of receiving the value of ten lowest hits or retiring the exercise.

(3) If the firer did not fire the required number of rounds through his own fault, he is given a miss for each unfired round.

d. All rounds fired before the command COMMENCE FIRING or after the command CEASE FIRING are scored as misses.

e. All rounds fired are recorded even though the rifle may have been accidentally discharged.

f. Ricochet hits are recorded as misses.

g. During rapid fire exercises, the firer is given an abbi for a failure of the rifle to function properly due to mechanical defects or to defective ammunition. It is the responsibility of the firer to immediately notify an officer or noncommissioned

officer on the line to have his malfunction verified. He is required to retire the exercise. If time or ammunition allocation does not permit retiring the exercise, the soldier may fire the remaining rounds with a time limit of 4 seconds per round.

h. If a target is withdrawn just as a shot is fired during slow fire, the shot is disregarded and the firer is given another round.

i. If a target is withdrawn during a rapid fire exercise, the firer is permitted to retire the complete exercise.

j. In case of slow target operation during slow fire, the firer must notify an officer or noncommissioned officer on the line before completing the exercise in order to receive additional time.

k. As a general rule in scoring rapid fire targets, only those hits which are visible will be scored. An exception will be made in the case where the grouping of three or more shots is so close that it is possible for a required shot or shots to have gone through the enlarged hole without leaving a mark. In this case, the firer will be given the benefit of the doubt and scored a hit.

APPENDIX D

TARGET DETECTION EXERCISES

1. General

a. The exercises outlined in this appendix serve as the basis for the target detection training conducted in conjunction with any of the rifle marksmanship courses. Target detection periods of instruction are listed in numerical sequence; however, this denotes only the recommended sequence of instruction and has no relation to the numerical periods of a specific marksmanship course.

b. Army Subject Schedule 23-72 may be used as a guide for a target detection program; however, detailed information can be found in this appendix.

c. The ammunition is based on the number of rounds used in each presentation and demonstration, assuming one rehearsal for each presentation and demonstration.

Note. One initial rehearsal should be conducted for each target detection exercise. Additional rehearsals are required only if target men are changed. A presentation refers to each time one exercise is conducted. Count a rehearsal as a presentation.

2. Target Detection Exercises

a. *Period One, Introduction to Target Detection (2 hours).* The purpose of this period is to teach each soldier the necessary skills and methods of detecting, marking, and determining the range to realistic battlefield targets.

(1) *Range facilities.* Two target detection ranges.

(2) *Personnel.*

(a) Two principal instructors (one for each range).

(b) Eight assistant instructors (four for each range).

(c) Six target men (three for each range).

Note. One principal instructor is needed at each range. He has the responsibility for setting up the range, waiting target men, and conducting the class. Four assistant instructors are needed for each range. They control the observers, assist in scoring, and must be thoroughly familiar with the position of the targets. The six target men, three for each range, must be trained to perform the duties of "targets." Each one is assigned a number of target placements within a certain area, and all target men are given a target trial card containing only the trial numbers and the indications he is to perform.

(3) *Blank ammunition requirements.*

For each presentation of—

First hour: 5 rounds for demonstration.

Second hour: 15 rounds for practice exercise.

For each rehearsal of—

First hour: 5 rounds.

Second hour: 15 rounds.

(4) *Master trial sheet*

Sample Master Trial Sheet
Period 1

Trial No.	Target Man	Action	Location	Range (meters)	Dist.
1	1	1. Slightly exposed, motionless 2. Raise and lower head, slowly. 3. Repeat 2 (above), rapidly. 4. Fire one blank round.	A-E	22	41A
2	2	1. Slightly exposed, motionless 2. Move head from side to side, slow. 3. Raise head slow, drop feet. 4. Fire one blank round.	B-D	66	31B
3	3	1. Slightly exposed, motionless 2. Move forward and back each 10 seconds. 3. Stop out and back rapidly. 4. Fire two blank rounds.	E-F	161	11C
CHANGE TARGET-LOCATIONS					
4	1	1. Slightly exposed, motionless 2. Shake each each 5 seconds. 3. Raise and lower head slowly with shiny helmet liner. 4. Fire two blank rounds.	G	119	13E
5	2	1. Kneeling partially exposed (motionless) 2. Move head and shoulders from side to side, slowly. 3. Jump out and back each 5 seconds. 4. Fire one blank round.	C	44	32A

Trial No.	Target man	Action	Location	Range (meters)	Shot
6	3	1. Slightly exposed, motionless 2. Assume kneeling position slowly. 3. Raise up slow, drop fast. 4. Fire two blank rounds. CHANGE TARGET LOCATIONS	D	95	19B
7	1	1. Partially exposed, kneeling 2. Raise head slow, drop fast. 3. Repeat 1 (above) rapidly. 4. Fire two blank rounds.	B	91	29B
8	2	1. Slightly exposed, motionless 2. Slow up and down movement. 3. Rapid, jerky movement. 4. Fire one blank round.	D	51	27
9	3	1. Slightly exposed, motionless 2. Move head and shoulders side to side, slowly. 3. Same as 1 (above) with shiny helmet liner. 4. Fire one blank round. CHANGE TARGET LOCATIONS	A-D	41	29A
10	1	1. Slightly exposed 2. Slow movement. 3. Fast movement. 4. Fire two blank rounds.	D-E	88	28B

Note. An individual target trial card (Fig 87) should be prepared for each target man. It should contain only those trials in which he participates, the location (table number) used, and the action performed in each trial. Although each target man has been thoroughly rehearsed, the target trial cards will insure that no mistakes are made.

(5) *Answer sheet.* See figure 160. DA Form 3009-R (Answer Sheet, Periods One, Two, and Eight) will be reproduced locally on 8-by-10½-inch paper.

b. *Period Two, Detection of Realistic Battlefield Targets (2 Hr).* This period is conducted in the same manner as period one, but on a different range if possible. Range facilities, personnel, organization, ammunition requirements, master trial sheet, and answer sheet are the same as outlined for period one.

c. *Period Three, Detection of Single Moving Targets (2 Hr).* The purpose of this period is to give the soldier practice in detecting and simulating the engagement of single, combat-type, moving targets.

(1) *Range facilities.* One target detection range.

(2) *Personnel.*

(a) One principal instructor.

(b) Three target men.

**TARGET DETECTION EXERCISE
ANSWER SHEET
PERIODS 1, 2, AND 3**

For use of this form, see FM 23-8 and FM 23-9; proponent agency is TRADOC.

NAME	(LAST)	(FIRST)	PLATOON	SQUAD	DATE	
TRIAL NO.	PHASE NUMBER				WHERE (LETTER OF NEAREST LANDMARK)	RANGE (METERS)
	1	2	3	4		
4 -----						
4 -----						
3 -----						
4 -----						
5 -----						
5 -----						
7 -----						
4 -----						
4 -----						
10 -----						
11 -----						
12 -----						
13 -----						
14 -----						
15 -----						
16 -----						
TOTAL						

DA FORM 3009-R, 1 Nov 73 REPLACES DA FORM 3009-R, 1 JUN 66, WHICH IS OBSOLETE.

Figure 160. Answer sheet, periods one, two, and eight (DA Form 3009-R).

**TARGET DETECTION EXERCISE
ANSWER SHEET
PERIODS 1, 2, AND 3**

For use of this form, see FM 23-8 and FM 23-9; proponent agency is TRADOC.

NAME		(LAST)	(FIRST)	PLATOON	SQUAD	DATE
		<i>TORRES</i>	<i>BRYAN</i>	<i>3 D</i>	<i>3 D</i>	<i>30 JULY 1973</i>
TRIAL NO.	PHASE NUMBERS				WHERE (LETTER OF NEAREST LANDMARK)	RANGE (METRES)
	1	2	3	4		
1 -----	X	✓			<i>C</i>	<i>50</i>
2 -----	X	X	✓		<i>D</i>	<i>75</i>
3 -----	X				<i>B</i>	<i>50</i>
4 -----	X	X	X	✓	<i>F</i>	<i>278</i>
5 -----	X	✓			<i>A</i>	<i>83</i>
6 -----	X	X	✓		<i>E</i>	<i>115</i>
7 -----	X				<i>C</i>	<i>196</i>
8 -----	X	✓			<i>B</i>	<i>58</i>
9 -----	X	X	X	X		
10 -----	X	X	✓		<i>F</i>	<i>280</i>
11 -----	X	✓			<i>D</i>	<i>89</i>
12 -----	X	✓			<i>B</i>	<i>63</i>
13 -----	X	✓			<i>A</i>	<i>90</i>
14 -----	X	X	✓		<i>B</i>	<i>70</i>
15 -----	✓				<i>E</i>	<i>120</i>
16 -----	✓				<i>C</i>	<i>230</i>
TOTAL	<i>16</i>	<i>18</i>	<i>8</i>	<i>1</i>		

DA FORM 3009-R, 1 Nov 73

REPLACES DA FORM 3009-R, 1 JUN 60, WHICH IS OBSOLETE.

(Sample of DA Form 3009-R with entries.)
Figure 160—Continued.

- (3) *Blank ammunition requirements.*
 Rounds per presentation 10
 Rounds per rehearsal 10

- (4) *Master trial sheet.*

**Sample Master Trial Sheet
Period 3**

Trial No.	Target man	Range (meters)	Description of requirements	State No.
1	1	200	1. Standing by tree 2. Kneel slowly, 3. Slow movement from view.	26A.
2	2	150	4. Fire two blank rounds. Same as trial 1 (above) at poor aiming point.	28B.
3	3	175	Start standing. Disappear; on command reappear in same position. Make four 4-costed rushes to good aiming points. CHANGE TARGET MEN LOCATIONS	27C-28C-29C-30C-32C.
4	1	300	Start from kneeling position behind bush. Make five rushes. Disappear at poor aiming points. Reappear from same position. 5-3-3-5-5, fire one blank round from last position.	1A-2A-3A-4A-5A-6A.
5	3	300	Start prone. Make five rushes. Disappear after each rush and roll or crawl to a new location before reappearing. 3-3-3-6-8, fire one blank round from last position.	1C-2C-3C-4C-5C-6C.
6	2	175	Start prone. Make five lateral rushes. Reappear at same location. 4-5-4-4-5, fire one blank round from last position. CHANGE TARGET MEN LOCATIONS	28B-29B-30B-31B-32B-33B.
7	2	175	Run six in reverse	33B-32B-31B-30B-29B-28B.
8	3	200	Run 100 meters from tree to position with poor aiming point.	25C-29C.
9	1	260	Start prone. 5-L-3-3-4-B-4-5, through draw, fire one blank round from last position. (Numbers indicate duration of rush; letters indicate direction of roll or crawl after each rush.)	6A-7A-8A-9A-10A-11A.
10	2	300	Start behind bush. 6-6-B-3-R-4-3; fire one blank round from last position.	1B-2B-3B-4B-5B-6B.

15) *Answer sheet.* See figure 161. DA Form 8010-R (Answer Sheet, Period three) will be reproduced locally on 8- by 10½-inch paper.

TARGET DETECTION EXERCISE

ANSWER SHEET

PERIOD 3

For use of this form, see FM 23-8 and FM 23-9; proponent agency is TRADOC.

NAME	PLATOON	SQUAD	DATE
TRIAL NO.	WHERE (LETTER OF NEAREST LANDMARK)		RANGE (METERS)
1			
2			
6			
6			
6			
6			
6			
7			
6			
6			
10			

DA FORM 3910-R, 1 Nov 73 REPLACES DA FORM 3910-R, 1 JUN 69, WHICH IS OBSOLETE.

Figure 161. Answer sheet, period three (DA Form 3910-R).

**TARGET DETECTION EXERCISE
ANSWER SHEET
PERIOD 3**

For use of this form, see FM 23-8 and FM 23-9; proponent agency is TRADOC.

NAME	PLATOON	SQUAD	DATE
TORRES, BRYAN	3 D	3 D	30 JULY 1973
TRIAL NO.	WHERE (LETTER OF NEAREST LANDMARK)	RANGE (METERS)	
1	V G	V 86	
2	X A	X 90	
3	V E	V 110	
4	V B	V 225	
5	V C	V 50	
6	X F	V 120	
7	V G	V 86	
8	V D	V 105	
9	V H	V 75	
10	V A	V 125	

DA FORM 3010-R, 1 NOV 72 REPLACES DA FORM 3010-R, 1 JUN 68, WHICH IS OBSOLETE.

(Sample of DA Form 3010-R with entries.)
Figure 161—Continued.

d. *Period Four, Detection of Multiple Moving Targets (2 Hr).* The purpose of this period is to give the soldier practice in detecting and aiming at multiple, combat-type, moving targets.

(1) *Range facilities.* Two target detection ranges.

(2) *Personnel.*

(a) Two principal instructors (one for each range).

(b) Eight assistant instructors (four for each range).

(c) Sixteen target men (eight for each range).

(3) *Organization.* One order of observers is assigned to each range.

(4) *Blank ammunition requirements.*

Rounds per presentation 47

Rounds per rehearsal 47

(5) *Master trial sheet.* (Observers use target aiming device to mark the points of disappearance of moving targets.)

Sample Master Trial Sheet
Period 4

Trial No	Target man	Range (meters)	Description of requirements	Stake No
1	1	75	Kneeling exposed. Crawl to new position in five 5-meter crawling movements. Fire one blank round from each new position. 15 rounds per target man. Good aiming points.	42A-43A-44A-45A-46A-47A. 40B-41B-42B-43B-44B-45B.
	2			
2	3	100	Same as above. Poor aiming points, but reference points available.	39A-40A-41A-42A-43A-44A.
	4			
3	5	300	Start with targets walking through woods or other partial concealment.	37B-38B-39B-40B-41B-42B. 9A-10A-11A-12A-13A-14A.
	6			
4	7	200	Start from kneeling position behind bush. Make five rushes. Disappear where there is a poor aiming point. Reference points available but not easy. 4-2-4-4 seconds. one blank round from last position.	11B-12B-15B-14B-15B-16B. 7C-8C-9C-10C-11C-12C. 9C-10C-11C-12C-13C-14C. 12C-13C-14C-15C-16C-17C. 16C-15C-16C-17C-18C-19C.
	8			
5	4	300	CHANGE TARGET LOCATIONS Start prone. Make five rushes, good and poor aiming points. 2-4-6-2 seconds. Fire one blank round from last position.	8A-9A-10A-11A-12A-13A. 11A-12A-13A-14A-15A-16A. 10B-11B-12B-13B-14B-15B.
	5			
	6			
6	1	175	Start at tree. Make five rushes to new positions affording good and poor aiming points. 2-3-4-2 seconds. Fire one blank round from last position.	14A-15A-16A-17A-18A-19A. 18B-19B-20B-21B-22B-23B. 17C-18C-19C-20C-21C-22C. 19C-20C-21C-22C-23C-24C.
	2			
	3			
7	3	175	Start at different distance. Make five approach rushes. 4-2-4-3-4 seconds. Varied good and poor aiming points. Fire one blank from last position.	17A-18A-19A-20A-21A-22A. 13A-14A-15A-16A-17A-18A. 16A-17A-18A-19A-20A-21A.
	4			
	5			
8	1	200	CHANGE TARGET LOCATIONS Make five 5-meter crawling movements to positions with good aiming points. Reference points increase in difficulty each time. Fire one blank round from last position.	11A-12A-13A-14A-15A-16A. 12B-13B 14B-15B-16B-17B. 12C-13C-14C-15C-16C-17C.
	2			
	7			
9	3	300	Start walking in woods. Make five rushes. 4-2-2-6-4 seconds. Fire one blank round from last position.	9A-10A-11A-12A-13A-14A. 10B-11B-12B-13B-14B-15B. 10C-11C-12C-13C-14C-15C.
	4			
	5			
10	5	150	Make five rushes. 4-3-6-2-3 seconds. Fire one blank round from last position.	80A-21A-22A-23A-24A-25A. 81B-22B-23B-24B-25B-26B. 18B-19B-20B-21B-22B-23B. 19C-20C-21C-22C-23C-24C.
	4			
	5			
	6			

c. Period Five, Locating Target by Sound (2 hours). The purpose of this period is to give the soldier practice in locating targets by the sound of firing from hostile firing position.

(1) *Range facilities.* One target detection range.

(2) *Personnel.*

(a) One principal instructor.

(b) One assistant instructor per ten observers.

(c) Five target men.

(3) *Organization.* One order of observers on the range at a time.

(4) *Blank ammunition requirements.*

Rounds per presentation 46

Rounds per rehearsal 46

Master Trial Sheet
Period 5

Trial No.	Target man	Pool location	Trial No.	Target man	Pool location
CHANGE TARGET LOCATIONS					
1	1	14	15	4	1
2	2	11		5	3
	3	4	16	1	10
3	4	7	17	3	5
	5	9		2	9
4	1	14	18	4	1
	2	11		1	10
5	3	4	19	2	5
6	4	7	20	5	3
7	5	9		2	9
	2	11	21	4	1
				3	5
CHANGE TARGET LOCATIONS			CHANGE TARGET LOCATIONS		
8	1	2	22	1	3
	3	8	23	2	9
9	4	12	24	3	14
10	2	11		4	10
	5	6	25	3	3
11	1	8		1	3
	4	12	26	2	9
12	1	2		3	14
	2	13	27	4	10
13	4	12		5	3
	3	6	28	4	3
14	3	3			

(6) Answer sheet. See figure 162. DA Form 3011-R (answer sheet, period five) will be reproduced locally on 8- by 10½-inch paper.

f. Period Six, Detection of Movement by Opposing Teams, Personal Camouflage. The purpose of this period is to give soldiers practical work in

target detection and movement as target teams, and to conduct demonstrations and practical work in personal camouflage.

(1) Range facilities. Two target detection ranges.

TARGET DETECTION EXERCISE

ANSWER SHEET

PERIOD 5

For use of this form, see FM 23-8 and FM 23-9; the proponent agency is TRADOC.

OBSERVER'S NAME	(LAST)	(FIRST)	PLATOON
------------------------	---------------	----------------	----------------

OBSERVATION POINT	DATE
--------------------------	-------------

TRIAL NO.	SOUND POSITION	TRIAL NO.	SOUND POSITION
1 -----		15 -----	
2 -----		16 -----	
3 -----		17 -----	
4 -----		18 -----	
5 -----		19 -----	
4 -----		20 -----	
7 -----		21 -----	
8 -----		22 -----	
8 -----		23 -----	
10 -----		24 -----	
11 -----		25 -----	
12 -----		26 -----	
13 -----		27 -----	
14 -----		28 -----	

TOTAL -----	RIGHT -----	WRONG -----
-------------	-------------	-------------

DA FORM 3011-R, 1 Nov 73 REPLACES DA FORM 3011-R, 1 JUN 69, WHICH IS OBSOLETE.

Figure 162. Answer sheet, period five (DA Form 3011-R).

**TARGET DETECTION EXERCISE
ANSWER SHEET
PERIOD 5**

For use of this form, see FM 23-8 and FM 23-9; the proponent agency is TRADOC.

OBSERVER'S NAME (LAST)		(FIRST)		PLATOON	
TORRES		BRYAN		3 D	
OBSERVATION POINT				DATE	
23				30 JULY 1964	
TRIAL NO.	SOUND POSITION	TRIAL NO.	SOUND POSITION		
1 -----	4-3	15 -----	6-13		
2 -----	6 X	16 -----	14-4		
3 -----	8	17 -----	8		
4 -----	12-14	18 -----	13		
4 -----	1-3 X	19 -----	6-5		
4 -----	7	20 -----	7-1X		
4 -----	4	21 -----	3		
8 -----	2-5	22 -----	7		
9 -----	9	23 -----	4		
10 -----	10-12	24 -----	7-12		
22 -----	4	25 -----	10-1		
12 -----	8 X	26 -----	8-4X		
13 -----	10	27 -----	3		
14 -----	1	28 -----	6-4X		
TOTAL -----		RIGHT <u>35</u>		WRONG <u>6</u>	

DA FORM 2011-R, 1 Nov 72 REPLACES DA FORM 1911-R, 1 JUN 69, WHICH IS OBSOLETE.

(Sample of DA Form 3011-R with entries.)
Figure 163—Continued.

**Movement by Trial
Period 6**

Trial No	(1) 8-sec rush	(2) 2-sec rush	(3) 5-m low crawl	(4) 4-sec rush	(5) 5-m low crawl	(6) 4-sec rush	(7) 10-m high crawl	(8) 2-sec rush	(9) 4-sec rush	(10) 50-m bound
1		X			X	X			X	X
2	X		X			X		X		X
3		X				X	X		X	X
4	X		X	X				X		X
5				X	X			X	X	X
6	X		X			X		X		X
7	X	X		X			X			X
8				X			X	X	X	X
9		X			X	X		X		X
10	X			X	X			X		X
11		X				X	X	X		X
12		X		X	X				X	X
13	X		X			X		X		X
14		X		X	X				X	X

Note: The above sample master trial sheet reflects 10 trials for 14 soldiers acting as targets. Units may revise the above master trial sheet to include additional target requirements to be used to ensure maximum participation when larger squads are used.

Figure 163. Time/movement master trial sheet.

(2) **Personnel.**

(a) Two principal instructors (one for each range).

(b) Four assistant instructors (two for each range).

(c) Four demonstrators (two for each range).

13) **Organization.** One order of observers is assigned to each range.

14) **Blank ammunition requirements.** None.

15) **Master trial sheet** (fig 163).

16) **Target Trial cards.**

Target Trial Card No. 1 (Target Man 1)

Trials: (2) 2-second rush; (5) 5-meter low crawl; (6) 4-second rush; (9) 6-second rush; (10) 50-meter bound.

Target Trial Card No. 2 (Target Man 2)

Trials: (1) 6-second rush; (3) 5-meter low crawl; (6) 4-second rush; (8) 2-second rush; (10) 50-meter bound.

Target Trial Card No. 3 (Target Man 5)

Trials: (2) 2-second rush; (6) 4-second rush; (7) 10-meter high crawl; (9) 6-second rush; (10) 50-meter bound.

Target Trial Card No. 4 (Target Man 4)

Trials: (1) 6-second rush; (3) 5-meter low crawl; (4) 4-second rush; (8) 2-second rush; (10) 50-meter bound.

Target Trial Card No. 5 (Target Man 5)

Trials: (4) 4-second rush; (5) 5-meter low crawl; (8) 2-second rush; (9) 6-second rush; (10) 50-meter bound.

Target Trial Card No. 6 (Target Man 6)

Trials: (1) 6-second rush; (5) 5-meter low crawl; (6) 4-second rush; (8) 2-second rush; (10) 50-meter bound.

Target Trial Card No. 7 (Target Man 7)

Trials: (1) 6-second rush; (2) 2-second rush; (4) 4-second rush; (7) 10-meter high crawl; (10) 50-meter bound.

Target Trial Card No. 8 (Target Man 8)

Trials: (4) 4-second rush; (7) 10-meter high crawl; (8) 2-second rush; (9) 6-second rush; (10) 50-meter bound.

Target Trial Card No. 9 (Target Man 9)

Trials: (2) 2-second rush; (5) 5-meter low crawl; (6) 4-second rush; (8) 2-second rush; (10) 50-meter bound.

Target Trial Card No. 10 (Target Man 10)

Trials: (1) 6-second rush; (4) 4-second rush; (5) 5-meter low crawl; (8) 2-second rush; (10) 50-meter bound.

Target Trial Card No. 11 (Target Man 11)

Trials: (2) 2-second rush; (6) 4-second rush; (7) 10-meter high crawl; (8) 2-second rush; (10) 50-meter bound.

Target Trial Card No. 12 (Target Man 12)

Trials: (2) 2-second rush; (4) 4-second rush; (5) 5-meter low crawl; (9) 6-second rush; (10) 50-meter bound.

Target Trial Card No. 13 (Target Man 15)

Trials: (1) 6-second rush; (3) 5-meter low crawl; (6) 4-second rush; (8) 2-second rush; (10) 50-meter bound.

Target Trial Card No. 14 (Target Man 14)

Trials: (2) 2-second rush; (4) 4-second rush; (5) 5-meter low crawl; (9) 6-second rush; (10) 50-meter bound.

Targets representing fire support should be located in a tactically sound position. Moving targets should be located generally to the flank of the maneuver area. Where rushing targets are widely

separated (100 meters or more), fire support may be centrally located.

g. *Period Seven, Combination of Sound and Multiple Moving Targets (2 hours).* The purpose of this period is to give soldiers practice in locating, marking, and aiming combinations of firing and moving combat-type targets.

111 *Range facilities.* Two target detection ranges.

121 *Personnel.*

(a) Two principal instructors (one for each range).

(b) Ten assistant instructors (five for each range).

(c) Sixteen target men (eight for each range).

(3) *Organization.* One order of observers assigned to each range.

(4) *Blank ammunition requirements.*
 Rounds per presentation 75
 Rounds per rehearsal 75

(5) *Master trial sheet.*

Sample Master Trial Sheet
 Period 7

Trial No.	Target man	Range (meters)	Description of requirements	Shot No.
1	1	150	Two targets make clumsy 5-meter crawl; two targets fire four blank rounds each toward the observation line. All located at good aiming points.	25A-31A
	2			25B-31B
	3			P14
	4			P3
2	5	200	Three targets make skilled 5-meter crawl; two target fire two blank rounds. All positions are good aiming points. Distance between targets 25 meters.	22A-23A
	6			20B-22B
	7			21C-23C
	8			P4
CHANGE TARGET LOCATIONS				
3	1	300	Two targets walking through woods. Disappear on command and make one 4-second rush. Two targets fire two blank rounds each.	1A-2A
	2			2B-3B
	3			1C-2C
	4			P12
4	5	250	Two targets make a 3-second rush and disappear at poor aiming points. Two targets fire three blank rounds each.	14B-15B
	6			13C-14C
	7			P13
	8			P10
CHANGE TARGET LOCATIONS				
5	1	100	One target makes a 5-meter crawl and stops at a good aiming point. One target makes a 5-meter rush, stops at a poor aiming point. One target makes a 10-meter rush. One target fires five blanks.	31A-32A
	2			31B-32B
	3			29C-31C
	4			P9
6	5	150	Three targets make a 5-meter clumsy crawl. One target fires two blank rounds. All positions at poor aiming points. Good reference points available.	27B-28B
	6			26C-27C
	7			25A-26A
	8			P2
CHANGE TARGET LOCATIONS				
7	1	225	Two targets make a skilled 5-meter crawl. Two targets fire two blank rounds each. All positions with a good aiming point.	P11
	2			P1
	3			13C-14C
	4			14B-15B
8	5	300	Three targets walk through woods until fired on from observation line. Disappear and make a 5-meter crawl. One target fires four blank rounds.	P6
	6			3C-3C
	7			2A-3A
	8			2B-3B
CHANGE TARGET LOCATIONS				
9	1	150	Same as above except all targets stop at poor aiming points.	24A-25A
	2			25B-24B
	3			P6
	4			26C-27C
10	5	225	Two targets make a 5-second rush. Two targets fire one blank round each toward the observation line.	15C-17C
	6			P2
	7			19B-20B
	8			P7
CHANGE TARGET LOCATIONS				
11	1	250	Four targets fire one blank round each.	P11
	2			P13
	3			P9
	4			P12

Trial No.	Target man	Range (meters)	Description of requirements	Mark No.
12	5	100	One target makes a 10-meter rush to a poor aiming point. Three targets fire two blank rounds each.	P6
	6			F10
	7			F4
	8			39B-42B
CHANGE TARGET LOCATIONS				
13	1	200	Two targets fire one blank round each. Two targets make a 5-meter crawl. Varied good and poor aiming points.	11A-12A
	2			9E-10B
	3			F2
	4			F5
14	5	75	Same as above except all positions at poor aiming points and require the use of color-cue points.	F3
	6			F1
	7			44B-45B
	8			44C-45C
CHANGE TARGET LOCATIONS				
13	1	225	Two targets spaced far apart make a 3-second rush. Two targets close together fire two blank rounds each.	8A-9A
	2			7C-8C
	3			F14
	4			F11
16	5	275	Four targets make 1-, 2-, 3-, 4-second rushes after being fired on from the observation line. Each target fires one blank round 2 seconds after disappearing. Varied, good, and poor aiming points.	13A-16A
	6			14B-13B
	7			16B-15B
	8			14C-15C
17	1	125	Four targets alternately fire one round each; varied, good, and poor aiming points.	36A
	2			35A
	3			31B
	4			32C
18	5	300	Two targets make a 1-second rush; two targets fire one blank round each. Varied, good, and poor aiming points.	F9
	6			F13
	7			1A-2A
	8			2C-3C
CHANGE TARGET LOCATIONS				
19	1	125	Three targets make a 3-second rush and one target fire one blank round.	35A-34A
	2			36A-37A
	3			31B-32B
	4			32C-33C
20	5	175	One target makes a 3-meter crawl and three targets fire one round each. Varied, good, and poor aiming points.	25B-24B
	6			F14
	7			F11
	8			F1

16) Answer sheet. See figure 164, DA Form 3012-R (Answer Sheet, period seven) will be reproduced locally on 8- by 10 $\frac{1}{4}$ -inch paper.

a. Period Eight, Target Detection Test One (1

hr). The purpose of this period is to test the soldier's ability to locate and determine targets to single, stationary battlefield targets.

TARGET DETECTION EXERCISE ANSWER SHEET PERIOD 7			
For use of this form, see FM 23-8 and FM 23-9; proponent agency is TRADOC.			
COMBINATION OF SOUND LOCALIZATION AND MULTIPLE MOVING TARGETS (OBSERVERS CHECK EACH OTHER'S ALIGNMENT AND PLACE NUMBER OF TARGETS CORRECTLY ALIGNED IN SPACE OPPOSITE APPROPRIATE TRIAL NUMBER.)			
NAME		PLATOON	DATE
TRIAL NO.	NO. CORRECT	TRIAL NO.	NO. CORRECT
1		12	
2		13	
3		14	
4		15	
5		16	
6		17	
7		18	
8		19	
9		20	
10		TOTAL CORRECT	
11			
TRIAL NO.	NO. CORRECT	TRIAL NO.	NO. CORRECT
1		12	
2		13	
3		14	
4		15	
5		16	
6		17	
7		18	
8		19	
9		20	
10		TOTAL CORRECT	
11			

DA FORM 3012-R, 1 Nov 72 REPLACES DA FORM 3012-R, 1 JUN 68, WHICH IS OBSOLETE.

Figure 164. Answer sheet, period seven (DA Form 3012-R).

**TARGET DETECTION EXERCISE
ANSWER SHEET**

PERIOD 7
For use of this form, see FM 23-8 and FM 23-9; progression agency to TRADOC.

COMBINATION OF SOUND LOCALIZATION AND MULTIPLE MOVING TARGETS (OBSERVERS)
CHECK EACH OTHER'S ALIGNMENT AND PLACE NUMBER OF TARGETS CORRECTLY ALIGNED IN
SPACE OPPOSITE APPROPRIATE TRIAL NUMBER.

NAME		PLATOON		SERIAL		DATE	
TORRES, BRYAN		3 D		3 D		30 JULY 1973	
TRIAL NO.	NO. CORRECT	TRIAL NO.	NO. CORRECT	TRIAL NO.	NO. CORRECT	TRIAL NO.	NO. CORRECT
1	1	12	4	2	3	13	2
2	3	3	2	4	1	14	2
3	2	4	3	5	1	15	3
4	1	5	1	6	0	16	1
5	3	6	0	7	0	17	3
6	1	7	2	8	3	18	1
7	0	8	3	9	1	19	38
8	2	9	1	10	3	TOTAL CORRECT	
9	2	10	1	11	1	38	
10	3	TOTAL CORRECT		38			
11	1	TRIAL NO.	NO. CORRECT	TRIAL NO.	NO. CORRECT	TRIAL NO.	NO. CORRECT
12	0	17	2	18	0	19	1
13	2	19	1	20	1	21	2
14	2	21	1	22	3	23	2
15	1	22	3	24	1	25	3
16	3	23	2	26	2	27	1
17	3	24	1	28	3	29	2
18	1	25	3	30	1	TOTAL CORRECT	
19	4	26	2	31	1	34	
20	2	27	1	TOTAL CORRECT		34	
21	2	28	3				
22	1	29	2				
23	1	30	1				

DA FORM 3013-R, 1 Nov 72 REPLACES DA FORM 3013-R, 1 JUN 69, WHICH IS OBSOLETE.

(Sample of DA Form 3013-R with entries.)
Figure 164—Continued.

(1) *Range facilities.* One target detection mngn.

(2) *Personnel.*

(a) One principal instructor.

(b) Seven assistant instructors.

(c) Three target men.

(3) *Blank ammunition requirements.*

Rounds per presentation 15

Rounds per rehearsal 15

(4) *Master trial sheet.* Same as used for Period 1 except locations of target men should be changed.

(5) *Answer sheet.* Same as used in Period 1 (fig 160).

Three (1 Hr.) The purpose of this period is to test the soldier's ability to locate and mark the points of disappearance of single and multiple moving targets and his ability to locate sound targets.

(1) *Range facilities.* One target detection range.

(2) *Personnel.*

(a) One principal instructor.

(b) Four assistant instructors.

(c) Four target men.

(3) *Blank ammunition requirements.*

Rounds per presentation 30

Rounds per rehearsal 30

(4) *Master trial sheet and answer sheet, target detection Test Two.*

i. Period Nine, Target Detection Tests Two and

Sample Master Trial Sheet
Period 9
(Test Two)

Trial No.	Target man	Range (meters)	Description of requirements	Range No.
1	1	300	Kneeling by tree, up on command. Ten-meter bound to a poor aiming point.	1A-2A
2	2	75	Rush 15 meters to a poor aiming point.	40A-41A
	3			59B-60B
	4			40C-41C
CHANGE TARGET LOCATIONS				
3	1	200	Rush 10 meters to poor aiming points.	11A-12A
	2			13A-14A
	3			11B-12B
	4			11C-12C
4	1	150	Ten-meter lateral rush. Good aiming points.	12A-12B
	2			14A-14B
	3			12B-12C
	4			12C-11B
CHANGE TARGET LOCATIONS				
5	1	200	One man rush right, the other left, both stop at poor aiming points.	13A-12B
	2			12C-11B
6	3	75	Ten-meter rush. One to a good aiming point and the other two to poor aiming points.	35C-36C
	4	100		29B-30B
	1	125		27A-28A
CHANGE TARGET LOCATIONS				
7	2	75	Five-meter rush to poor aiming points.	34B-35B
	3			36C-35C
	4			35A-35B
8	1	200	Twenty-meter rush to a poor aiming point.	16A-17A
9	2	300	One rush 5 meters to a good aiming point and the other 10 meters to a poor aiming point.	1B-2B
	3			1C-3C
10	4	150	Five-meter lateral rush to poor aiming points.	25A-26A
	1			24B-25B

(5) *Answer sheet.* See figures 165. DA Form 3014-R (Answer sheet, period nine) will be reproduced locally on 8- by 10 $\frac{1}{2}$ -inch paper.

16] *Master trial sheet, target detection Test Two, sound detection.*

Sample Master Trial Sheet
 Period 9
 (Test Three)

Trial No.	Target area	Point location
1	1	6
2	2,2	4,12
3	4,1	7,9
4	2	8
5	3	14
6	4,1	14,3
7	2	1
8	3	6
9	4	7
10	1,2	13,8
11	3,4	10,1
12	1,2	2,6
13	3,4	7,3
14	1,2	11,6
15	2	7
16	4	3
17	1,2	6,14
18	3,4	12,1
19	1	8
20	2	3

(7) Answer Sheet. See figure 165.

**TARGET DETECTION EXERCISE
ANSWER SHEETS TESTS NO. 2 AND 3**

PERIOD 9

For use of this form, see FM 23-8 and FM 23-9; the proponent agency is TRADOC.

OBSERVER'S NAME		(LAST)	(FIRST)	PLATOON
OBSERVATION POINT				DATE
TRIAL NUMBER	NO. OF TARGETS PRESENTED	RIGHT	WRONG	
1	3			
2	3			
3	4			
4	3			
4	2			
6	3			
7	3			
6	2			
6	2			
10	3			
TOTAL		RIGHT	WRONG	

DA FORM 2014-R, 1 Nov 73 REPLACES DA FORM 2014-R, 1 APR 66, WHICH IS OBSOLETE.

Figure 165. Answer sheet, period nine (DA Form 2014-R).

**TARGET DETECTION EXERCISE
ANSWER SHEETS TESTS NO. 2 AND 3**

PERIOD 9

For use of this form, see FM 23-8 and FM 23-9; the proponent agency is TRADOC.

OBSERVER'S NAME (LAST)		OBSERVER'S NAME (FIRST)		PLATOON		
TORRES		BRYAN		3 D		
OBSERVATION POINT				DATE		
23				4 AUG 1964		
TRIAL NUMBER	NO. OF TARGETS PRESENTED	RIGHT	WRONG			
1	3	1	0			
1	3	2	1			
3	4	1	3			
4	1	3	1			
4	2	2	0			
4	3	2	1			
7	3	2	1			
7	1	1	0			
4	3	1	1			
10	1	2	0			
TOTAL		25	RIGHT	17	WRONG	8

DA FORM 3014-R, 1 NOV 72 REPLACES DA FORM 3014-R, 1 APR 66, WHICH IS OBSOLETE.

(Sample of DA Form 3014-R with entries.)
Figure 165—Continued.

INDEX

	Paragraph	Page		Paragraph	Page
Aiming	38	64	Immediate action	20	40
Aiming bar	45	84	Kneeling positions	39	71
Aiming device (fig 88)	110	110	Launcher, grenade, with sight	32,33	56,59
Aiming device, M2	45	84	Lubricants	22	41
Aiming point	38	64	Magazine loading	17	28
Acquisition:			Maintenances:		
Care, handling, preservation	29	56	Normal	24	51
Description	27	54	Special	25	51
Packaging	28	56	Marksmanship:		
Appearance-of-objects method	71	110	Conduct of firing	45	84
Automatic firing:			Conduct of training	45	84
Fire distribution	88	136	Firing exercise	45	84
Integrated unit	82	133	Rasorial instruction	45	84
Magazine handling	87	135	Marksmanship, advanced:		
Precision	83	128	Aiming	114	178
Qualification	89	137	Effects of weather	118	192
Target and range	89	137	Positions	115	183
Training, Conduct of	89	137	Sight adjustment	117	190
Types of fire	56	135	Sniper scope (fig 131)	116	189
Automatic rifle fire	18	30	Trigger control	119	197
Barrel/receiver group disassembly,			Zeroing	81	99
assembly	9,10	10,15	Marksmanship fundamentals	19	89
Battlefield conditions, common	3	3	M2 aiming device	45	84
Battlelight zero	51	94	One hundred meter unit of		
Bayonet/sawbar	31	56	measure (fig 90)	114	114
Bipod, M2	39	56	Positions, firing	39	71
Breaching	38	64	Progress booklet, firing	45	84
Calling the shot	42	81	Progress check	50	94
Caster of target techniques	38	98	Prove positions	39	71
Cleaning materials	22	41	Qualification:		
Cold climate maintenance	25	51	Automatic	89	137
Combat targets, types	3	3	Semiautomatic	106	178
Cookoff	19	39	Quick fire:		
Crack and thump technique	76	129	Field firing	93	153
Data, rifling	5	7	Technique	92	151
Disassembly/assembly:			Range, firing, 25-meter	45	84
Barrel and receiver group	9,10	10,13	Range operation:		
Chast	8	8	Facilities	62	99
Clearing rifle	7	8	Fire commands	63	100
Gas system and handguards	12,13	23	Organization	63	100
Magazine	16	34	Personnel	63	100
Sublimar assembly	14,15	34	Procedure	63	100
Three main groups	5,11	8,20	Soring	63	100
Disassembly authorization			Standard field firing range	63	100
Equipment, cleaning	22	41	Target device (fig 84)	102	102
Fire commands	45	84	Range, target detection (fig 85)	106	106
Firing attachment, blank, with			Rear sight collimation	54	96
breach shield	34	60	Rear sight maintenance	24	51
Firing data card (fig 76)	45	84	Receiver/barrel group disassembly,		
Firing exercise	37	64	assembly	9,10	10,15
Firing positions	39	71	Recoil, Effects of	37	64
Followthrough	41	81	Record fire:		
Foxhole position	39	71	Range organization:		
Functioning, rifle:			Conduct of firing, daytime:		
Automatic	18	30	Alibi firing	98	157
Semiautomatic	18	30	Fire commands	98	157
Grenade launcher with sight	32,33	56,59	Record fire I	98	157
Grip of the left hand	38	64	Record fire II	98	157
Grip of the right hand	38	64	Conduct of firing, nighttime:		
Haagflite	20	40	Facilities/equipment	101	162
Rat climate (humid, sandy) maintenance	25	51			

	Paragraph	Page		Paragraph	Page
Fire commands	104	170	Sights, rifle:		
Firing, Conduct of	103	169	Changes	49	94
Safety	102	169	Elevation / windage	48	93
Scoresheet	105	170	Rear	47	92
Scoring mechanism	105	170	Spot weld	38	64
Target area	101	162	Standard field firing range	63	100
Target detection	100	161	Standing positions	39	71
Troop movement on ranges (fig 120, 121, 122)	104, 165, 166		Stock weld	38	64
Firms	97	154	Stoppages, common	19	39
Firing arm	97	154	Stoppages, Reduction of	58	98
Personal	97	154	Target box exercise	45	84
Retired area	97	154	Target engagement	56	98
Relaxation	38	64	Target engagement, Positions of	59	98
Reloading, rapid	57	98	Target detection:		
Remedial marksmanship	45	84	Catch and thump	76	120
Rifle cleaning procedures:			Range:		
Bolt face	23	42	Aiming device	69	107
Chamber and bore	23	42	Construction	67	105
Gas cylinder / plug	23	42	Expendable area	68	107
Gas piston	23	42	Location	66	105
Spalls valve	23	42	Personal / equipment	69	107
Stabilizer assembly	23	42	Team	75	120
Rifle, clearing	7	8	Training concepts	65	105
Rifle, cycle of operation:			Training, Conduct of:		
Chambering	18	30	Determining range	71	110
Cocking	18	30	Appearance of objects	71	110
Ejecting	18	30	One hundred meter salt of assistance	71	110
Retracting	18	30	Engaging targets	72	118
Feeding	18	30	Fundamentals	71	110
Firing	18	30	Locating targets	71	110
Locking	18	30	Marking targets	71	110
Unloading	18	30	Searching area	71	110
Rifles:			Secure sketch	71	110
Data	5	7	Target indications	71	110
M14	4	5	Target loads	72	118
M14 (modified)	4	5	Training policies	79	122
M14A1	4	5	Target loads (fig 94)	107	178
Rifle sights	47-49	92	Target mechanism operation	60	99
Rifle, three main groups:			Target, 25-meter (fig 82)	96	
Barrel and receiver	8	8	Total card, target detection (fig 87)	108	
Firing mechanism	8	8	Trial sheet, target detection (fig 86)	107	
Stock	8	8	Trigger control	38	64
Scoresheet, record (see fig 118)		158	Trigger finger	38	64
Sector sketch (fig 93)		117	Three main groups, assembly	11	20
Semiautomatic rifle fire	18	30	Wind, Effects of	56	98
Shooting, (agreed act of):			Winter trigger kit	35	60
Aiming	58	64	Wobbles area	40	81
Steady hold factors	58	64	Zeroing:		
Shot group analysis	45, fig 74	82, 83	Battleflight	52, 53	95, 96
Shoulder, rifle butt on	58	64	Principles of	51	94
Sight alignment	58	64			
Sight picture	58	64			

By Order of the Secretary of the Army:

CREIGHTON W. ABRAMS
General, United States Army
Chief of Staff

Official:

VERNE L. BOWERS
Major General, United States Army
The Adjutant General

Distribution:

Active Army, ARNG, USAR: To be distributed in accordance with DA form
12-11A requirements for US Rifle—7.62MM, M14 and M14A1 (Qty req block no.
186).

♦ U.S. GOVERNMENT PRINTING OFFICE : 1992 O - 311-631 (60172)